

Peristaltic Pumps

Chemical dispensers for dishwashing machines

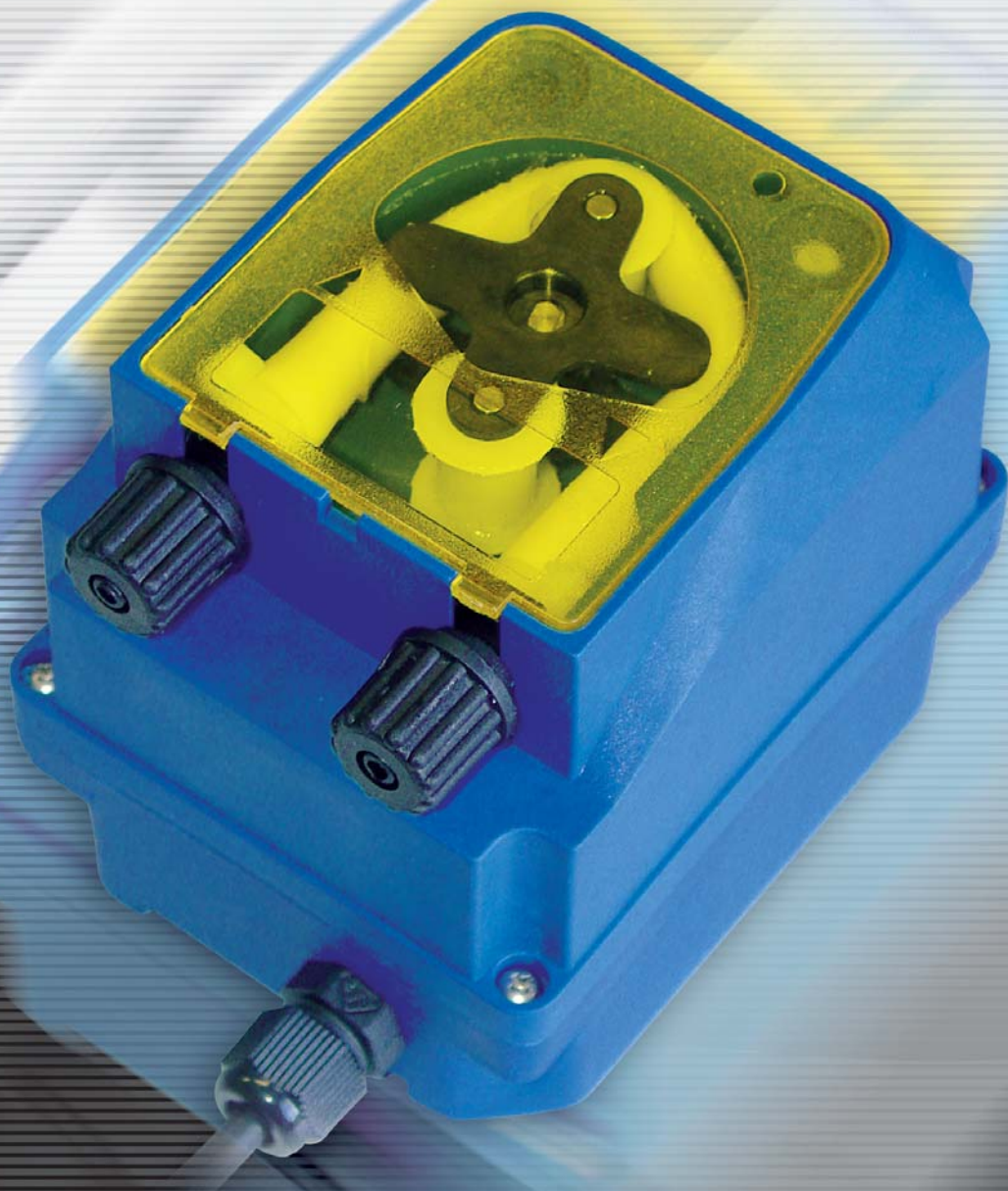

innovation > technology > future

Solutions for each dosing needs

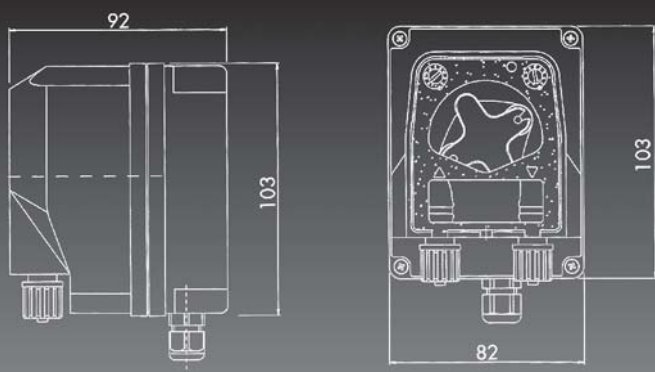

SEKO dosing pumps comply with the provisions contained in the following international standards:

- > 73/23CEE of 19/2/73
- > 89/336CEE of 3/5/89
- > EN60335-1
- > ISO 9001 (version 2000)

Safe and Reliable

Polypropylene enclosure extremely shockproof and resistant to chemical aggression

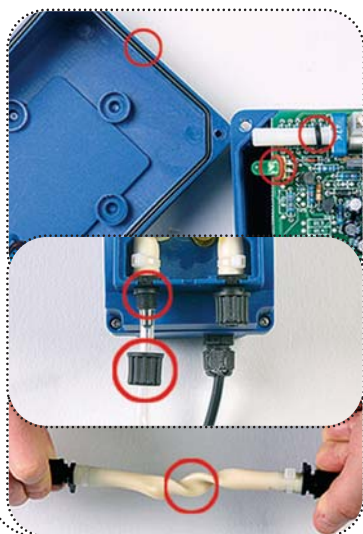

IP 65 protection degree and **class 2 electrical insulation** (no ground connection required)

Extra-strong and long life Santoprene and Sekobril squeeze tubing, always equipped with inlet-outlet fittings for fast and safe connections

User friendly

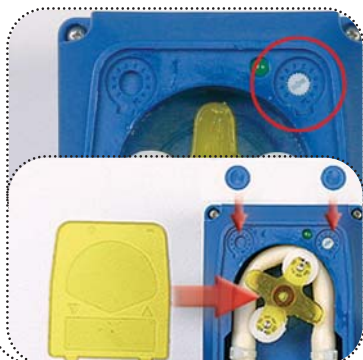

Via trimmer settings simple and fast parameters configuration

Plugs for protecting settings to avoid undesired tampering

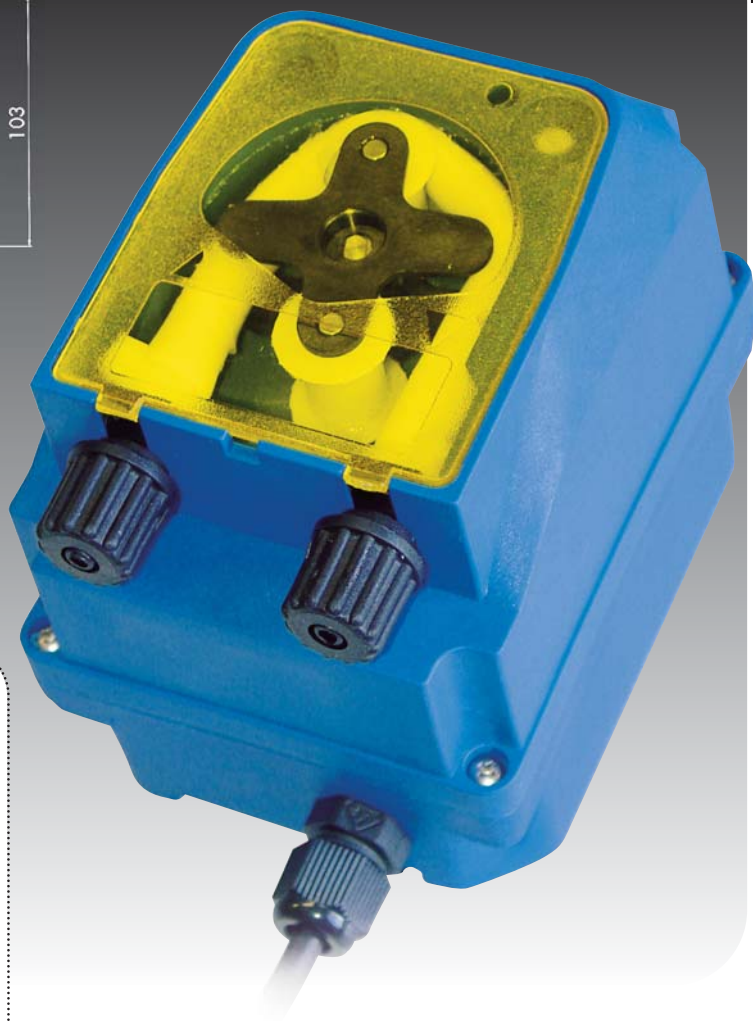

Easy installation Minimum maintenance

Easy wall mounting and removing thanks to the fixing brackets

Plugs on circuit board provide for a quick electrical connection

Easy tubing replacements. There's no need to start the pump

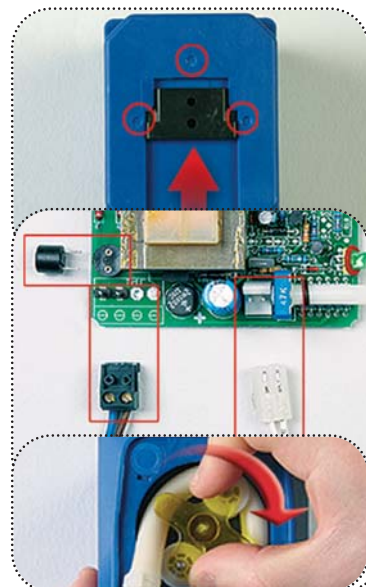

Peristaltic Pumps for *Detergent*

PA Fixed speed peristaltic pump with analogic dosing adjustment by conductivity probe



Power supply 230 Vac 50-60 Hz (24 Vac 50-60 Hz upon request)

Power consumption 3.5 W

PA 6 (Santoprene squeeze tubing)	0.1 bar	6 lt/h
PA 9 (Santoprene squeeze tubing)	0.1 bar	9 lt/h

PE Fixed speed peristaltic pump



Power supply 230 Vac 50-60 Hz (24 Vac 50-60 Hz upon request)

Power consumption 3.5 W

PE 1.5 (Santoprene squeeze tubing)	0.1 bar	1.5 lt/h
PE 3 (Santoprene squeeze tubing)	0.1 bar	3 lt/h

PR Peristaltic pump with analogic speed adjustment



Power supply 230 Vac 50-60 Hz (24 Vac 50-60 Hz upon request)

Power consumption 3.5 W

PR 4 (Santoprene squeeze tubing)	0.1 bar	0.6...4 lt/h
PR 7 (Santoprene squeeze tubing)	0.1 bar	1.2...7 lt/h

PRT Fixed speed peristaltic pump with analogic adjustment of dosing time



Models powered via single or double solenoid valves available.

Two setting trimmers enable detergent Initial Charge and Make Up Charge.

Power supply 230 Vac 50-60 Hz (24 Vac 50-60 Hz upon request) • **Power consumption** 3.5 W

Initial Charge time 18 to 180 sec. • **Make Up Charge time** 2 to 15 sec.

PRT 6 (Santoprene squeeze tubing)	0.1 bar	6 lt/h
PRT 9 (Santoprene squeeze tubing)	0.1 bar	9 lt/h

Peristaltic Pumps for *Rinse Aid*

PE 0.4 Fixed speed peristaltic pump



Power supply 230 Vac 50-60 Hz (24 Vac 50-60 Hz upon request)

Power consumption 3.5 W

PE 0.4 (Sekobril squeeze tubing)	3 bar	0.4 lt/h
---	--------------	-----------------

PR I Peristaltic pump with analogic speed adjustment

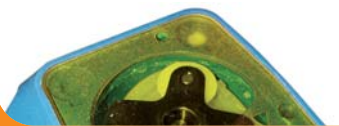

Power supply 230 Vac 50-60 Hz (24 Vac 50-60 Hz upon request)

Power consumption 3.5 W

PR 1 (Sekobril squeeze tubing)	3 bar	0.2...1 lt/h
---------------------------------------	--------------	---------------------

PM Fixed speed peristaltic pump with analogic adjustment of dosing time



A trimmer enable rinse aid dosing time.









Power supply 230 Vac 50-60 Hz (24 Vac 50-60 Hz upon request)

Power consumption 3.5 W • **Dosing Time** 1 to 25 sec.

PM 0.4 (Sekobril squeeze tubing)	3 bar	0.4 lt/h
PM 1.5 (Sekobril squeeze tubing)	3 bar	1.5 lt/h

Installation kit and Accessories

Installation Kit

							
Conductivity probe	Wall mounting bracket	PP injection connector	Stainless Steel non return valve	Boiler non return valve adapter Ø 6-8 mm	Foot filter	PVC Suction tubing	PE Delivery Tubing
PA	all pumps	PA • PE PR • PRT	PE 0.4 PRI • PM	PE 0.4 PRI • PM	all pumps	all pumps	all pumps

Accessories

							
Level control system*	Flexible conduit holder**	Double wall mounting bracket	Plastic T connector	Suction device without level probe	Suction device with level probe	Stainless Steel injection connector	Low profile injection connector
all pumps	all pumps	all pumps	PE 0.4 PRI • PM	all pumps	PR	PA • PE PR • PRT	PA • PE PR • PRT

* With every type of dosing pump. Two end of product alarm input via level probe in the form of a reed contact signalled with the flashing of the LED. Supplementary Output alarm relay available. Power supply: 230 Vac (24 Vac on demand) ** Ø internal 10mm, Ø external 16mm on demand



seko



SEKO Asia Pacific **SINGAPORE** • SEKO China **CHINA** • SEKO do Brasil **BRAZIL** • SEKO Dosing Systems **USA** • SEKO Southern Africa **SOUTH AFRICA** • SEKO Deutschland **GERMANY** • SEKO France **FRANCE** • SEKO Iberica **SPAIN** • SEKO Italia **ITALY** • SEKO SIETA **ROMANIA** • OOO SEKO **RUSSIA** • SEKO UK **UNITED KINGDOM**

ERTEK

www.ertek.com

**Ertek Yapı ve Makina Endüstri Ekipmanları
San. ve Tic. Ltd. Şti.**

Halkapınar Mah. Pamuk Plaza İş Merkezi 1082
Sokak No: 3 M 35170 Yenişehir Konak / İZMİR
Tel: (0232) 469 43 53 Faks: (0232) 457 46 51
www.ertek.com • info@ertek.com

BRO PRPUK 071

Technical data can be change without warning. Pictures and technical drawings are indicative only