

# Accessories



**seko**

innovation > technology > future

# Backpressure valves

The precision of electronic pumps is affected by fluctuations in pressure at the intake, especially between 0 and 1 bar. The backpressure valve keeps a constant pressure inside the pipeline during the dosage. In addition, dosing with a backpressure avoids siphoning from occurring in the pump.

## Series ST ajustables

Max pressure:	10 bar
Min pressure:	0,5 bar
Max flow rate:	500 l/h

### Descrizione

- PVC body, PTFE diaphragm, FPM seals, 4/6 and 8/12 tube connections
- PVC body, PTFE diaphragm, EPDM seals, 4/6 and 8/12 tube connections
- PVDF body, PTFE diaphragm, FPM seals, 3/4" DIN8063 connections

### Application field:

Dosing pumps Tekna, Maxima, Invikta, Spring (500 l/h max)



## VSM Series adjustables (FPM diaphragm)

MODEL (Material)	Flow Rate l/h	Pressure (bar)		Connections BSP	Code
		min	max		
VSM-S (AISI 316)	300	0	5	3/8" F	VSM1S03005
	800			3/4" F	VSM2S08005
	1500			1" F	VSM3S15005
VSM-P (PVC)	300	0	5	3/8" F	VSM1P03005
	800			3/4" F	VSM2P08005
	1500			1" F	VSM3P15005

Application field: Dosing pumps Spring series



## VZX Series (AISI 316)

MODEL	Flow Rate l/h	Pressure (bar)	Connections BSP	Code
VZX-S-02	50	2	1/4" M	VZX1S00502
	100		1/4" F	VZX3S01002
	200		3/8" F	VZX4S02002
	420		1/2" F	VZX5S04202
	800		3/4" F	VZX6S08002
	1650		1" F	VZX7S16502
VZX-S-10	100	10	1/4" F	VZX3S01010
	200		3/8" F	VZX4S02010
	420		1/2" F	VZX5S04210
	800		3/4" F	VZX6S08010
	1650		1" F	VZX7S16510

Application field: Dosing pumps Spring series



# Safety valves

To protect pumps, pipework and housing from pressure excess.

## PRM Series adjustables (FPM diaphragm)

MODEL (Material)	Flow Rate l/h	Pressure (bar)		Connections BSP	Code
		min	max		
PRM-S (AISI 316)	300	0	5	3/8" F	PRM1S03005
	800			3/4" F	PRM2S08005
	1500			1" F	PRM3S15005
PRM-P (PVC)	300	0	5	3/8" F	PRM1P03005
	800			3/4" F	PRM2P08005
	1500			1" F	PRM3P15005



## VS Series adjustables (AISI 316/PTFE)

MODEL	Flow Rate l/h	Pressure (bar)		Connections BSP	Code
		min	max		
VS1S	250	0	19	1/2" F	VS1S250019
		20	45		VS1S250045
		46	150		VS1S250150
VS2S	650	0	13	3/4" F	VS2S250013
		14	30		VS2S250030
		31	100		VS2S250100



**Application field:** Dosing pumps Spring series

## Multifunction valve

Multifunction valve acts as:

- A back pressure valve
- An anti-siphoning valve
- A safety valve
- A priming valve
- A delivery drain valve (for maintenance)

Materials		Connections
Valve body	Diaphragm	
PP	PTFE	4/6 (*)
PVC		
PVDF		

(\*) 5 bar type, supplied with 8/12 tube connections

Safety valve with pressure selection: 5(\*), 10, 15 bar

Back pressure valve with pressure: 1.5 bar

Maximum temperature of liquid: 40°

Multifunction valve is fitted directly on the delivery valve on the dosing pump.

**Application field:** Dosing pumps Tekna, Maxima, Invikta, Spring (100 l/h max)



## HY Series adjustables valves

Material:	PVC	Connections:	1/2" g.m., 8x12 tube, 4x6 tube
Max Flow rate:	50 l/h	Diaphragm:	FPM (standard) or EPDM (upon request)
Max pressure:	10 bar	Maximum temperature of liquid:	35 °C



HYC backpressure valves



Multi valve HYM



HYS Safety valves

## Injection valves

Material:	PVC	Connection OUT:	1/2" g.m.
Max flow rate:	50 l/h	Seals:	FPM (standard) or EPDM (on request)
Connection IN:	1/2" g.m., 8x12 tube, 4x6 tube	Max temperature:	35 °C

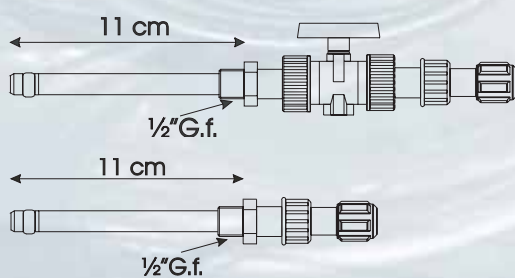

## Bleed valve

Gas inside the pump casing could compromise the correct functioning of the dosing pump. The bleed valve is used to automatically eliminate any gas that has built up inside the pump casing. The bleed valve is fitted directly on the delivery side of the dosing pump.

MATERIALS		Connections
Valve body	Diaphragm	
PP	PTFE	4/6
PP	PTFE	8/12
PVDF	PTFE	4/6
PVDF	PTFE	8/12



## Flow Sensor

In order to assess the actual dosing phase, the flow sensor can be used to detect the pump's pulsations during the delivery phase. In addition to checking that the pump is working properly, the sensor can also be used to determine the actual dosing flow rate. Using dosing pumps fitted with specific electronics makes it possible to automatically detect and assess the signals sent by the sensor.

This flow sensor is fitted directly on the delivery valve on the dosing pump.

MATERIALS		Connections
Body	Seals	
PVC	FPM	4/6
PVC	FPM	8/12

Maximum pressure: 10 bar

Maximum temperature of liquid: 40°

Contact reed: 12 V AC/DC, 0.5 A

**Application field:** Dosing pumps Maxima series 611, 612, 911, 912



## Priming-Aid

Priming problems may occur on dosing pumps with a low flow rate, and also in case of excessive suction heights in relation to the pump's capacity. This accessory is able to resolve these problems.

Where possible it is fitted at the same height as the pump's intake valve and a short distance from it.

MATERIALS		Connections	Model
Body	Seals		
PVC	FPM	4/6 - 8/12	300 ml

Maximum temperature of liquid: 40°

**Application field:** Dosing pumps Tekna, Maxima, Invikta, Spring (100 l/h max)



## FY Series suction filters

MODEL (Material)	Connections BSP	Code
FYP (PVC)	3/8" F	FYP3240200
	1/2" F	FYP3230040
	3/4" F	FYP3230060
	1" F	FYP3230080
FYP (AISI 316)	3/8" F	FYS3240098
	1/2" F	FYS3240100
	3/4" F	FYS3240110
	1" F	FYS3240120

**Application field:** Dosing pumps Spring series



# Pulsation bags

It's used to produce minimal pulsation dosing and to reduce flow resistance in long discharge lines.

## HST Series

Capacity (L)	Pressure (bar)	Material		Connections BSP	Code
		Body	Diaphragm		
0,04	10	PVC	FPM	3/8" F	HSTP004V01
0,1					HSTP010V01
0,35				1/2" F	HSTP035V01
0,8					HSTP080V01
1,5				3/4" F	HSTP150V01
2,3					HSTP130V01



## HTR Series

Capacity (L)	Pressure (bar)	Material		Connections BSP	Code
		Body	Diaphragm		
1,5	70	SS316	NBR	1" NPT	HTRS150N07
4,5	50			1" 1/2 NPT	HTRS450N05
10				2 BSP F	HTRSH10N05
0,35	230			3/8" BSP F	HTRS010N23
0,5				1/2" BSP F	HTRS035N23
0,8					HTRS050N23
1,5					HTRS080N23
2,3				3/4" BSP F	HTRS150N23
			HTRS230N23		



**Application field:** Dosing pumps Spring series

## Fitting-Testing unit AR series

Pressure (bar)	Code
6	AR10PM0006
12	AR11PM0012
40	AR01PM0040
60	AR02PM0060
100	AR03PM0100
160	AR04PM0160
250	AR05PM0250



## Mixers

Electric mixers threephase (singlephase on request) and flange attachment. For tanks SER series.

FAST MIXERS (1400 rpm)			
Body	Shaft length (mm)	Propeller diameter (mm)	Motor (kw)
PVC AISI316	600	90	0,13
	800		
	900		
	1100		

SLOW MIXERS (70 rpm)			
Body	Shaft length (mm)	Propeller diameter (mm)	Motor (kw)
PVC AISI316	600	150	0,13
	800	220	
	900		
	1100		



## Tanks in polyethylene

Our tanks are designed to assemble dosing group with mixers and motor driven pumps or solenoid dosing pumps. All are made of food-safe polyethylene, resistant to almost all chemicals normally encountered.

Model	Capacity (l)	Height (cm)	Diameter (cm)
SER 50	50	45.5	40
SER 100	100	64	45
SER 250	250	87	59,5
SER 300	300	95	67
SER 500	500	118.5	76
SER 1000	1000	122	108.5



## Uncovered Tanks

Designed to contain our tanks SER series

Model	Tank	Diameter (cm)	High (cm)	Capacity (L)
T150	SER100	51	75.5	150
T300	SER250	67	87.5	300
T400	SER300	72	99	400
T800	SER500	90	120	800
T1500	SER1000	122	134	1500

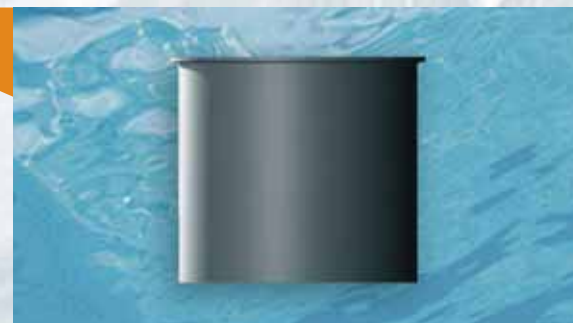

## Reinforcement

Tank reinforcement made of PVC (high 20 mm) to be used to install mixers and motor driven pumps or solenoid dosing pumps.

Model - Tank		Model - Tank		Model - Tank		Model - Tank		Model - Tank	
SML 100	SER 100	SML 250	SER 250	SML 300	SER 300	SML 500	SER 500	SML 1000	SER 1000



# Water Meters

The meters which we offer have high precision and sensitivity according to CEE standard requirements. Their plastic and metallic parts, in particular those in contact with water, comply with current regulations and are subject to extensive checks and controls.

## Threaded water meters

### Hdraulic data

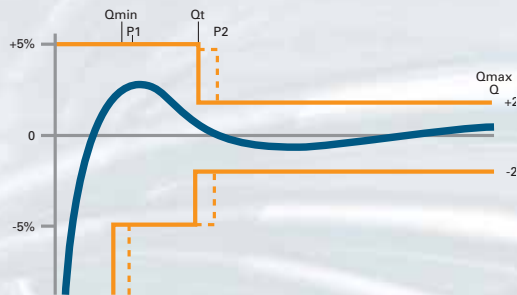
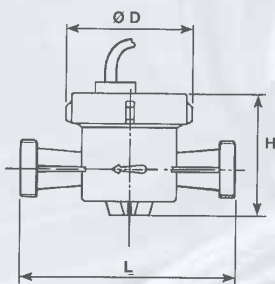

Size			mm	13	20	25	30	40	50
			Inch	1/2	3/4	1	1 1/4	1 1/2	2
Max flow (short period)	Q max	m <sup>3</sup> /h		3	5	7	10	20	30
Nominal flow		m <sup>3</sup> /h	Qn	1,5	2,5	3,5	5	10	15
Min flow (accuracy ±5%)	Q min	l/h		30	50	70	100	200	450
Transition flow (accuracy ±2%)	Qt	l/h		120	200	280	400	800	3000
Maximum reading		m <sup>3</sup>		10.000	10.000	100.000	100.000	100.000	100.000

### Dimensions

Size			mm	13	20	25	30	40	50
			Inch	1/2	3/4	1	1 1/4	1 1/2	2
Length without adapters	L	mm		110	130	160	160	200	300
Length with thread		mm		190	228	260	280	340	472
Width	D	mm		80	80	100	100	110	152
Height	H	mm		90	90	120	120	130	200
Maximum reading		m <sup>3</sup>		10.000	10.000	100.000	100.000	100.000	100.000

### Models

CONNECTIONS	CB Series	CB4 (4 pulse/l)	CBI (1 imp/l)
		Inch	mm
		1/2	13
		3/4	20
		1	25
		1 1/4	30
		1 1/2	40
		2	40

Single jet water meter, wet dial, roller reading for cold water up to 50 °C

CONNECTIONS	CN Series	CN4 (4 pulse/l)	CNI (1 pulse/l)
		Inch	mm
		1/2	13
		3/4	20
		1	25
		1 1/4	30
		1 1/2	40
		2	40

Single jet water meter, wet dial, roller reading for cold water up to 50 °C. For mounting electronic dosing pump.

CONNECTIONS	RBF Series		
		Inch	mm
		1/2	13
		3/4	20
		1	25
		1 1/4	30
		1 1/2	40
		2	40

Single jet water meter, wet dial, roller reading for cold water up to 50 °C Without pulse sender.

CONNECTIONS	HB Series	HB4 (4 pulse/l)	HBI (1 pulse/l)
		Inch	mm
		1/2	13
		3/4	20
		1	25
		1 1/4	30
		1 1/2	40
		2	40

Single jet water meter, wet dial, roller reading for hot water up to 90 °C



# Water Meters

## Threaded (Dry-dial magnetic coupling)

### Hidraulic data

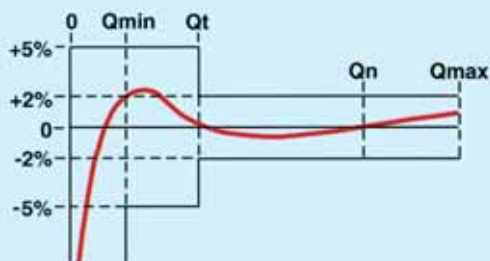
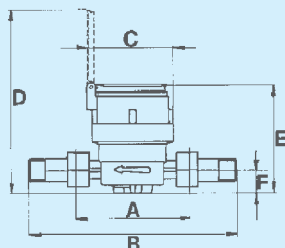

Size	mm		13	20	25	30	40
	Inch		1/2	3/4	1	1 1/4	1 1/2
Max flow (short period)	Q max	m³/h	3	5	7	10	20
Nominal flow	m³/h	Qn	1,5	2,5	3,5	5	10
Min flow (accuracy ±5%)	Q min	l/h	30	50	70	100	200
Transition flow (accuracy ±2%)	Qt	l/h	120	200	280	400	800
Maximum reading	m³		100.000	100.000	100.000	100.000	100.000

Size	mm		13	20	25	30	40
	Inch		1/2	3/4	1	1 1/4	1 1/2
Length without adapters	L	mm	110	130	160	160	200
Length with thread	mm		190	228	260	280	340
Width	D	mm	80	80	100	100	110
Height	H	mm	108	108	128	128	142

DR Series	DRI (1 pulse/l)	
	Inch	mm
CALIBRI DISPONIBILI	1/2	13
	3/4	20
	1	25
	1 1/4	30
	1 1/2	40

Single jet water meter, wet dial, roller reading for cold water up to 50 °C

## Flanged (Dry-dial magnetic coupling)

### Hidraulic data

Size	DN		50	65	80	100	150
	Inch		2	2 1/2	3	4	6
Max flow (short period)	Qmax	m³/h	30	50	80	120	300
Flow rate with 0.1 bar loss charge		m³/h	20	55	65	120	300
Nominal flow	Qn	m³/h	15	25	40	60	150
Min flow (accuracy ± 5%)	Qmin	m³/h	1.2	3	3.2	4.8	12
Transition flow (accuracy ± 2%)	Qt	m³/h	4.5	7.5	12	18	45

### Dimensions

Size	DN		50	65	80	100	150
	Inch		2	2 1/2	3	4	6
Length	L	mm	200	200	200	250	300
Width	D1	mm	165	185	200	220	285
Height	H	mm	247	258	265	272	302
Flange holes	Ø	mm	18	18	18	18	22
	n°		4	4	4	8	8
	D2	mm	125	145	160	180	240



WE Series	WE 25	WE 50	WE 100
Pulse/L	25	50	100
Connections DN (mm)	50	50	50
	65	65	65
	80	80	80
	100	100	-
	WE 250	WE 500	WE 1000
Pulse/L	250	500	1000
Connections	150	150	150

Water meters, with reading, for cold water up to 40°.

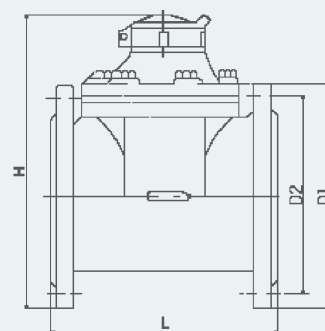

## Suction Devices

A suction filter is provided to protect pump valves from undesired substances that should compromise the flow rate.

Suction devices can also be supplied with integral level controls. These allow the use of alarms, and protect against the system running dry.

- Easy to install
- Standard FPM seals (EPDM upon request)
- Made of PCV with clear PVC suction tubing
- All suction devices are provided with a foot filter
- All suction devices are provided with a non return valve



Tube 4x6	Tube 8x12	Foot filter	No LEV	1 LEV	2 LEV	No return valve	Tank suitability
•	•	•	•	•	•	•	SER 50
•	•	•	•	•	•	•	SER 100
•	•	•	•	•	•	•	SER 250
•	•	•	•	•	•	•	SER 300
•	•	•	•	•	•	•	SER 500 e 1000

# Installation

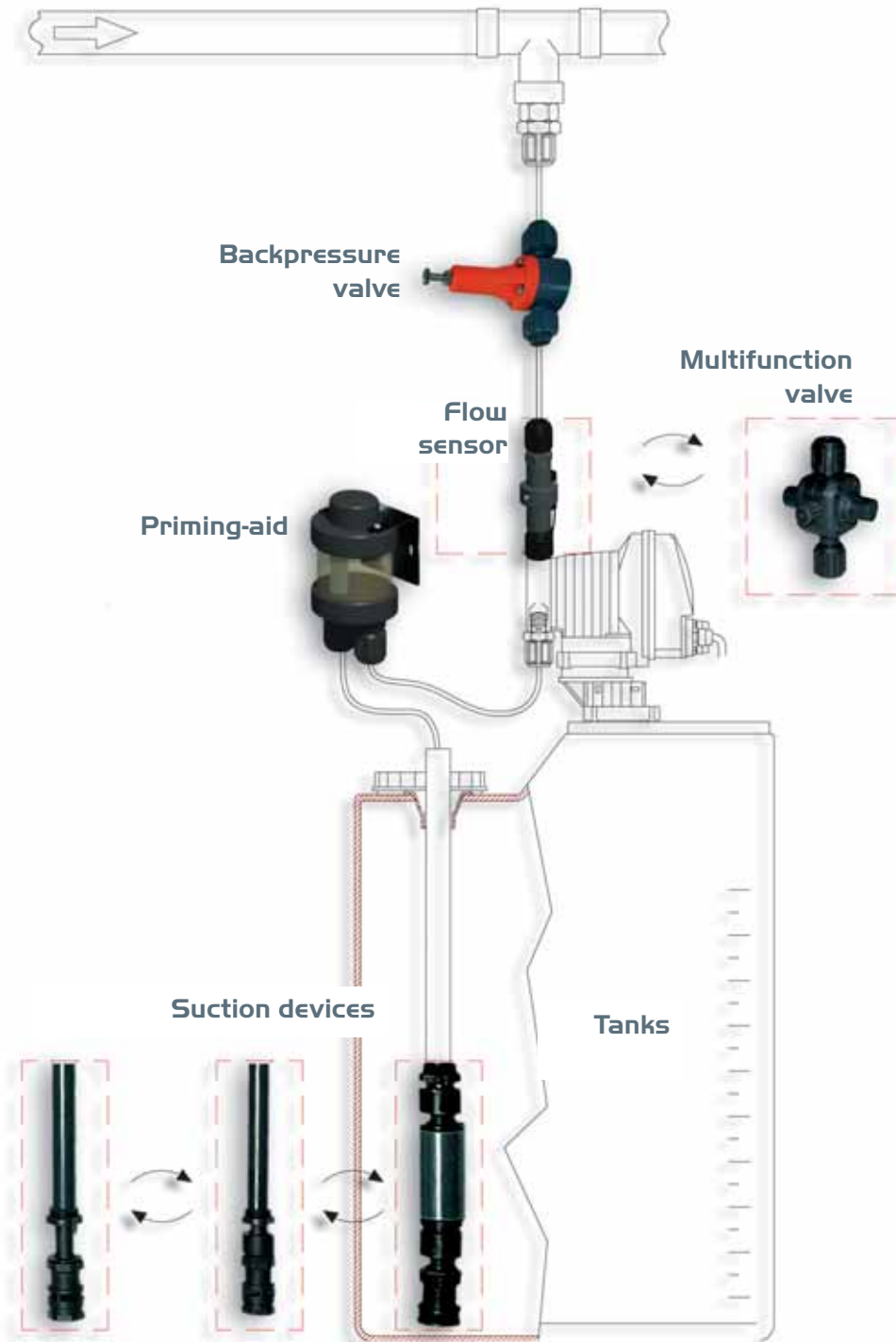

## TANKS AND PVC REINFORCEMENT



## WATER METER PULSE-SENDER



## MIXERS



## SUCTION DEVICES



## SAFETY VALVES



## BACKPRESSURE VALVES



## PULSATION DAMPNERS





SEKO do Brasil **BRAZIL** • SEKO China **CHINA** • SEKO France **FRANCE** • SEKO Deutschland **GERMANY** • SEKO Italia **ITALY**  
 OOO SEKO **RUSSIA** • SEKO Asia Pacific **SINGAPORE**  
 SEKO Southern Africa **SOUTH AFRICA** • SEKO Iberica **SPAIN**  
 SEKO UK **UNITED KINGDOM** • SEKO Dosing Systems **USA**

**ERTEK**  
[www.ertek.com](http://www.ertek.com)

**Ertek Yapı ve Makina Endüstri Ekipmanları  
 San. ve Tic. Ltd. Şti.**

Halkapınar Mah. Pamuk Plaza İş Merkezi 1082  
 Sokak No: 3 M 35170 Yenışehir Konak / İZMİR  
 Tel: (0232) 469 43 53 Faks: (0232) 457 46 51  
[www.ertek.com](http://www.ertek.com) • [info@ertek.com](mailto:info@ertek.com)