

EBARA

CF1007EA

BARRELLED MOTOR PUMP

Hzfree

Model MMF

50/60Hz

Pump for new generation

[Energy Saving]

[Space Saving]

[Non Leakage]

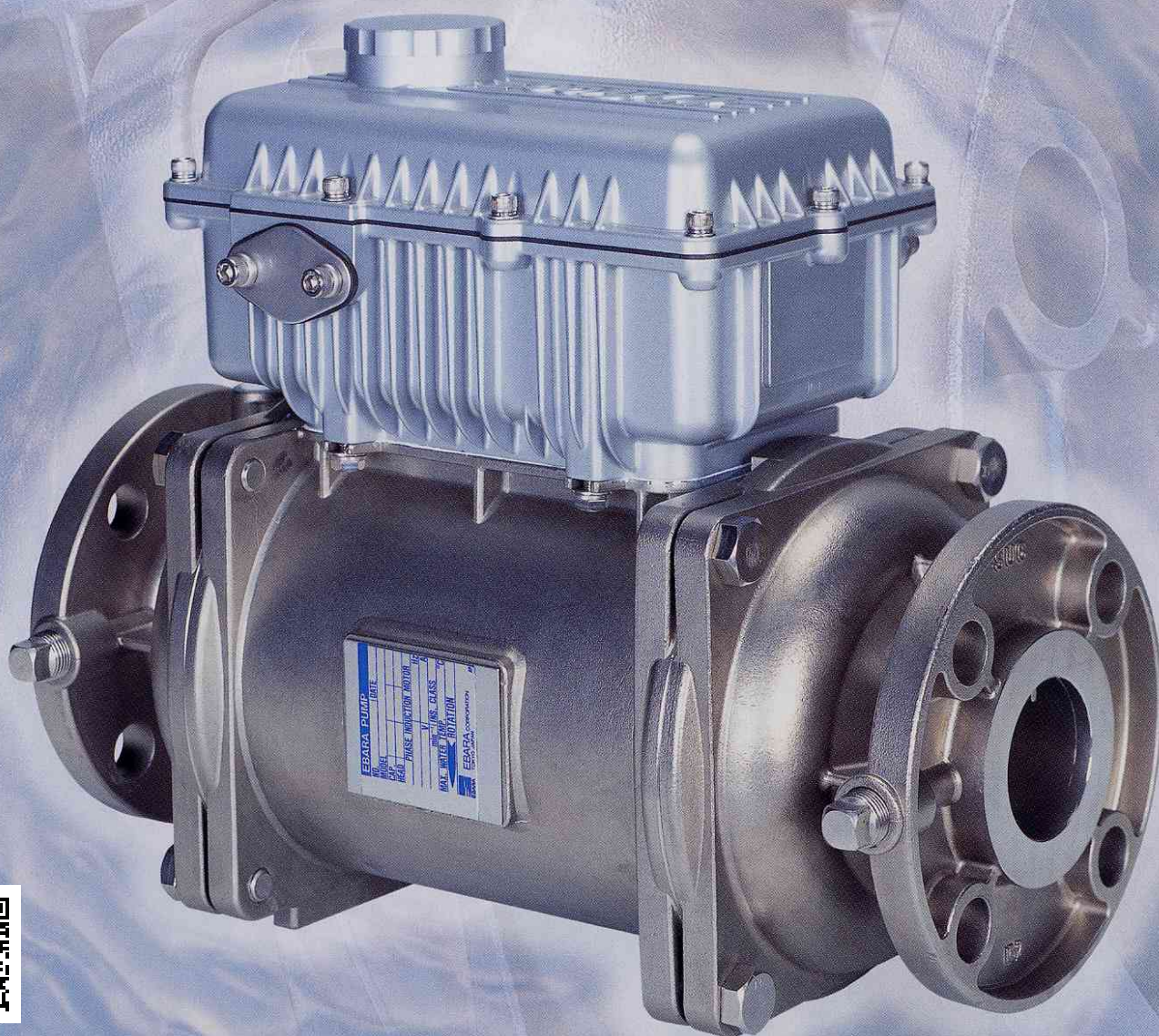

The Hzfree Series has Evolved Again

1 Inverter Installed Energy Saving Space Efficient

Failure signal output and variable speed function based on external signal input have been added to the previous manual operation (8-step manual control). Now **Hzfree** could be used in a wide range of application from simple on/off mode to advanced control operation.

Manual Operation - Optimal in Non-Variable Flow Conditions

Rotational speed (pump performance) can be adjusted in 8 stages with the turn of speed regulating dial. In comparison with valve flow adjustment, there is a substantial reduction in energy consumption, making it easy to conserve power during operation.

[Comparative example of electric power consumption]

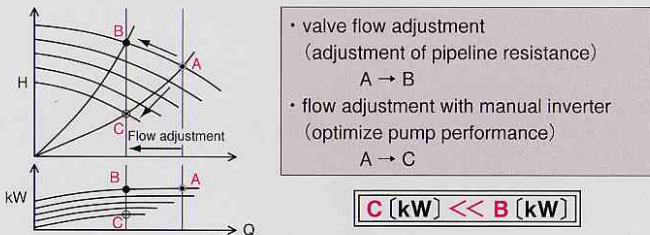

External Signal Control Operation - Optimal in Variable Flow Conditions

Variable speed operation is possible using an external current signal (4 to 20 mA). A range of automatic, variable-operation modes are possible through a combination of sensors and computing unit/transducers etc.

[example of use] Constant pressure control

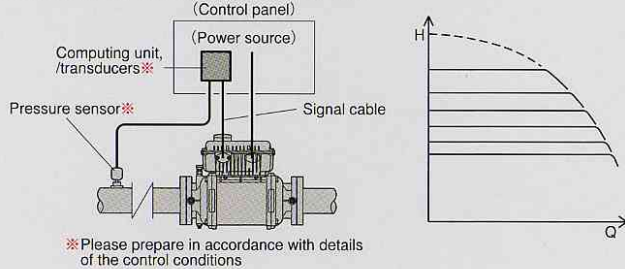

High Rotational Speed Operation ※※ - Reducing Size and Weight

Miniaturization of motor and pump has become a reality, with maximization of rotational speeds of approximately 10,000 revolutions per minute. This design means a saving in installation space and set-up operations (a comparison with Ebara horizontal end-suction pump model FS)

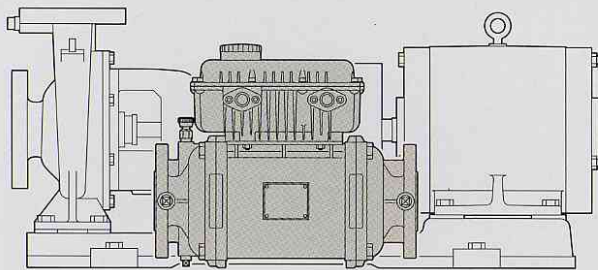

※※ By increasing rotational speed and reduce in size, the peripheral speed of the rotating parts outer diameter is equivalent to that of conventional models. Mechanical reliability is thus preserved even with the speed increase.

Vibration Reduction

Vibrating power is small because of the reduction in size and weight of the rotating parts. This means that for normal floor installation type pumps, special anti-vibration equipment is not necessary. Please use rubber vibration insulator.

2 Barreled Motor Space Saving Noise Reduction

The term "barreled motor" refers to the placement of the motor inside the barrel. Water flows around this exclusive motor, which will bring various features of the **Hzfree** pump.

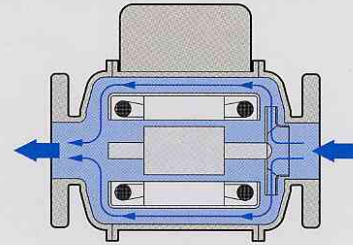

Reduced Size

Water in the surrounding area serves to cool the motor and the inverter. The resulting increase in cooling efficiency means that miniaturization becomes possible.

Noise Reduction

The water provides noise reduction, meaning that jarring high-frequency sound is largely controlled. Noise levels will be lower than 2 pole T.E.F.C motor, operating at maximum speeds.

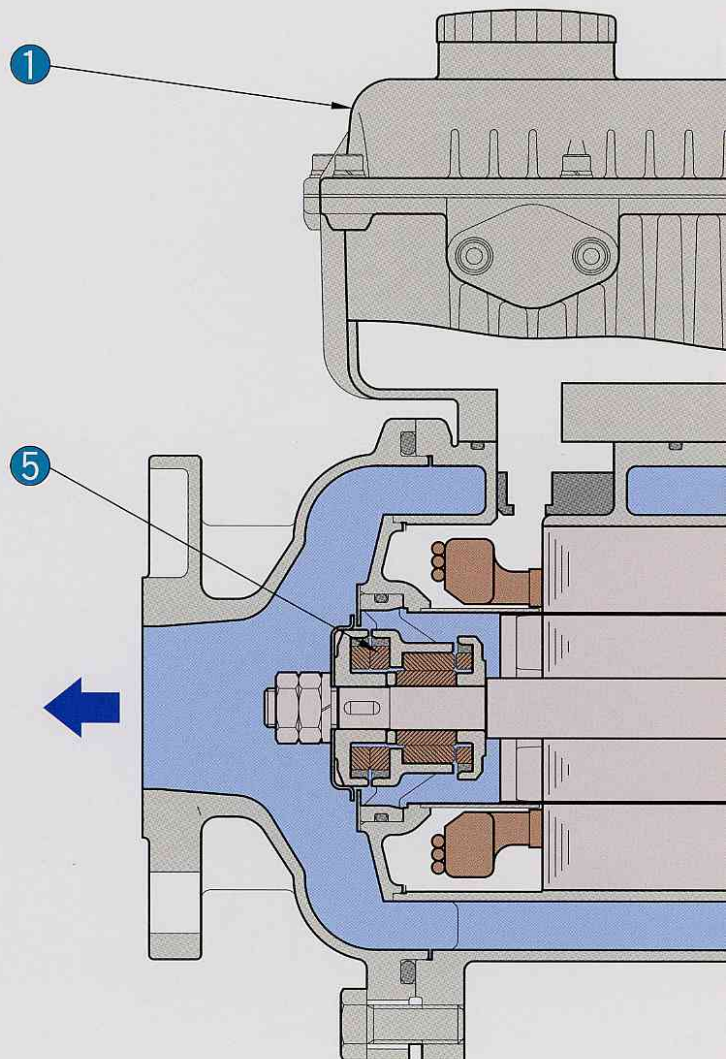

Quality with Energy Saving, Space Efficient, Non-leakage, Reduction, Cleanliness, and Low Maintenance.

3 Canned Motor **Non leakage** **Low Maintenance**

No shaft seal (without grand packing, mechanical seal) means no worries about leakage of liquid. The area around the pump stays clean, and there is less need for maintenance.

4 Stainless Steel **Cleanliness**

SCS (stainless steel casting) is used for the casing and barreled motor parts. Rust proof material is used for wetted parts, meaning water is kept clean.

5 High-endurance SiC bearing **Low Maintenance**



SiC(silicon carbide) bearings are adopted, providing outstanding wear and abrasion resistance. Spiral grooves are added to the bearing surface, making non-contact operation possible. Because of this, particles arising at the time of operation are controlled, and bearing life is extended.

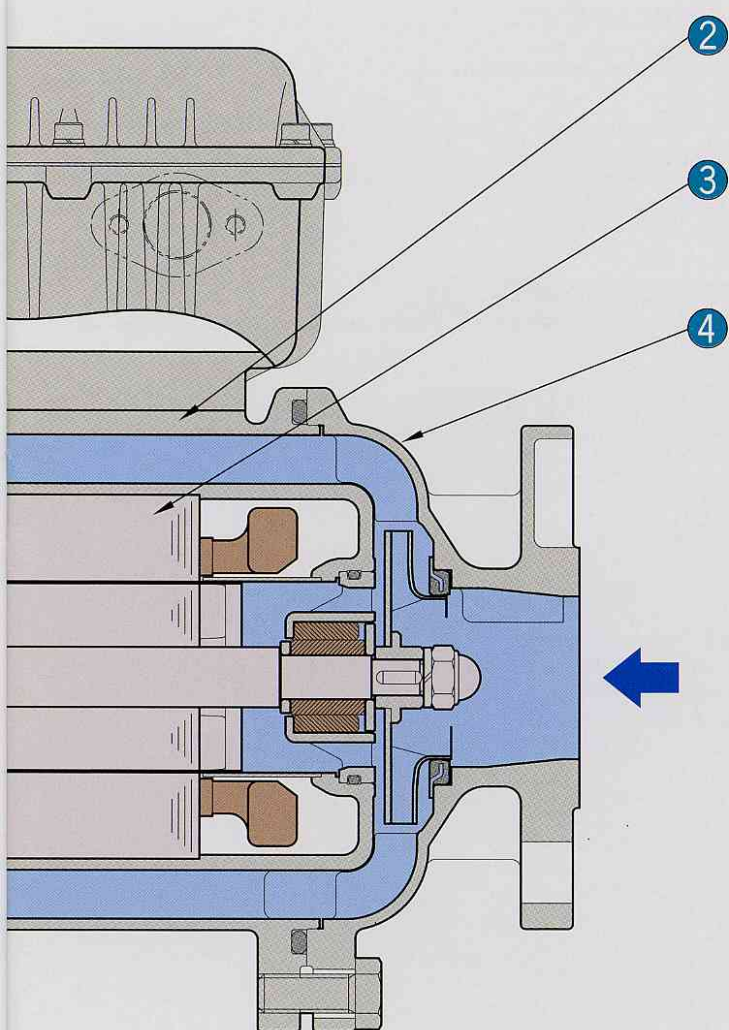
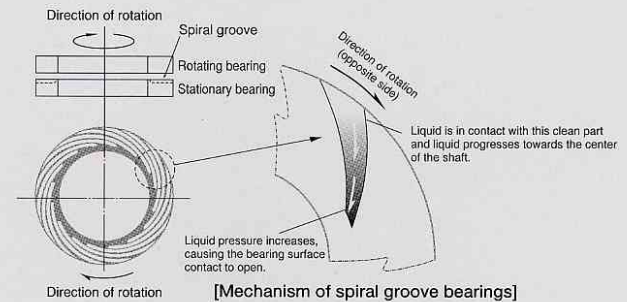

The inverter installed pump means

● **Protective Functions**

Protective functions have been added to the inverter. When a problem is detected, the pump is automatically stopped and the operation signal of the protective function is sent as output to the signal cable. The nature of the problem is indicated by a blinking trip lamp (for details, refer to page 5).

● **High - Frequency Noise Reduction**

The inverter case is made of aluminum, and there is no exposure of downstream wiring external facings, meaning a substantial reduction in high frequency noise.

● **Soft Start Function**

Rated rotational speed is reached within 3 seconds of power-up. There is little jarring at start-up, ensuring long-machine life and quiet operation. The current at start-up is less than during rated running conditions.

● **No Difficulties with Initial Set-Up**

All electrical characteristics, with the exception of rotation speed, are pre-set especially for each pump.

● **Reverse-Rotation Prevention**

Revolutions are always in the correct direction, regardless of the wiring connections. Mistakes in the wiring connection do not occur.

● **Easy Specification of Flow (verification of energy saving)**

Flow can be adjusted with a turn of a dial to match pressure gauges and pump efficiency curves.

● **Used with 50 or 60 Hz**

Operates at either frequency with the same performance.

Specifications

Location		Indoor or Outdoor (Max. altitude 1000m)※1	
Handling liquid		Fresh water※2 • 0~65°C (Ambient temp. Max.30°C)※3	
		Brine※4 • -10~40°C (Ambient temp. Max. 40°C)	
Max. working pressure		1.4MPa {14.3kgf/cm ² }	
Max. suction pressure		0.4MPa {4.1kgf/cm ² } or 0.6MPa {6.1kgf/cm ² }	
Pump	Construction	Impeller	Enclose
		Bearing	Silicon Carbide Sliding bearing
	Pipe connection	Suction side	JIS 10K Flange
		Discharge side	JIS 10K Flange
	Materials	Casing	Stainless steel casting (SCS13)
		Shaft	Stainless steel (SUS431)
Impeller		Stainless steel (SUS304 or SCS13)	
Liner ring		Rubber(EPDM) / Stainless steel (SUS304)	
Motor	Type		Barrelled type canned motor
	Phase / Pole		Three phase / 2 pole
Inverter	Protective construction		Hermetically sealed, equivalent to IP55
	Case material		Aluminum
	Input	Frequency	50/60Hz
		Phase / Voltage	Three phase 200, 220, 380, 400, 415, 440, 460V※5
	Output	Wave form	Sine wave PWM type
		Max. output frequency	Refer to dimension drawing
		Voltage / Frequency characteristic	V/F ² = Constant (Parabola decrease pattern)
Carrier frequency		13kHz (9kW and under), 10kHz (above 9kW)	
Operation	Start / stop operation		Power ON : Pump starts and reaches adjusted speed in 3 seconds Power OFF : Pump turns with inertia until stops
	Speed adjustment※6	Manual adjustment	Manually adjusted by Speed Regulating Dial (8 steps) and operating at constant speed
		External signal control	Automatic speed adjustment by external signal (4 - 20mA)
	Operation indication		Flashing of Run Lamp (orange)
	Fault indication		Blinking of Trio Lamp (red)

※1 No corrosive gas, explosive gas, oil mist or vapor.

※2 Fresh water is tap water, well water, and industrial water with pH levels of 5.8-8.6 and a chlorine content of 200 mg/l or less.

※3 Temperature of 0-60°C if the ambient temperature is 40°C and below.

※4 Acceptable brine solutions are limited to propylene glycol and ethylene glycol (calcium chloride can not be used). There may be a decrease in pump performance depending on specifics of viscosity and specific gravity. Performance degradation must be considered separately from.

※5 Acceptable voltage fluctuation is within plus or minus 10 percent (phase imbalance of within 3 percent). Acceptable frequency fluctuation is within plus or minus 5 percent. Acceptable simultaneous fluctuation of voltage and frequency is within 10 percent of the sum of their absolute values.

※6 Both "Manual adjustment" and "External signal control" methods are available.

Application: flooded or positive suction only

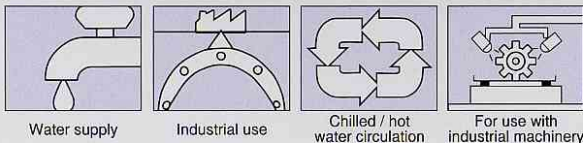

Water supply

Industrial use

Chilled / hot water circulation

For use with industrial machinery

Special characteristics of the *Hfree* are as follows

- **for built-in equipment**
Size of equipment could be minimized, and also could be operate by both 50 and 60 Hz.
- **designed for brine circulation**
No leaks means no problems with icing on the shaft seal.
- **can be used as a booster (series operation)**
Small size and leak-free design means installation is possible in pipe lines with insufficient pressure.
- **multiple pump control (parallel operation)**
Multiple pump operation is possible in installation space for one conventional model.

Standard Accessories

Flange packing 2sheets Signal cable length of 2.5m
Bolts & nuts for flange ... 2sets Rubber vibration insulator ... 1set
Power cable length of 2.5m (for floor installation type only)

Optional Accessories

- AC reactor

Optional Specifications

- **Floor installation type**
Bore size 32 - 50 pumps can be changed to a floor installation type.
- **Oil preventing treatment**
Parts cleaning, assembling, performance test, hot water cleaning, and inspection for oiliness prior to packing and shipping.
- **Degreasing treatment**
Assembling, performance test, and hot water cleaning before packing and shipping
- **Fluoro rubber versions**
Rubber material of wetted parts can be changed to fluoro rubber.

[Wiring Example]

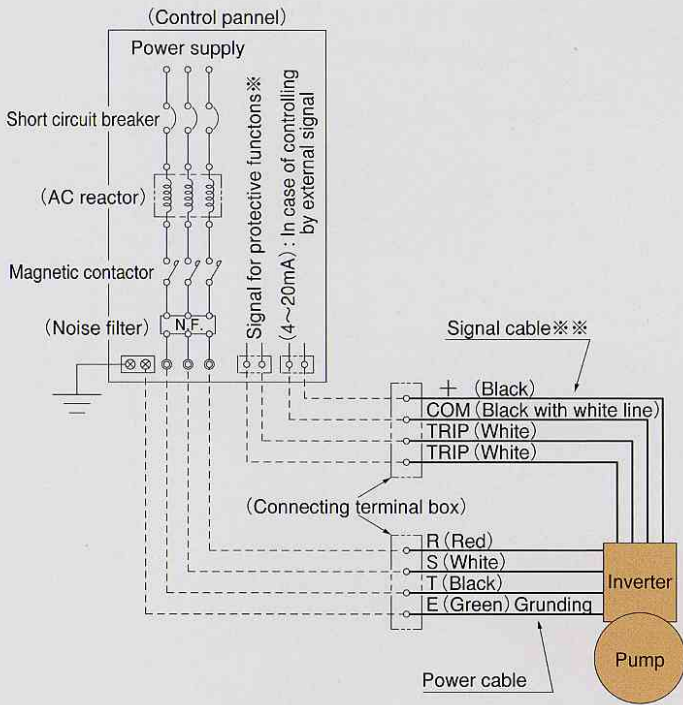

※

Caution This pump has protective functions and may stop in case of failure occurs. To detect the failure, it is necessary to install an alarm device in the control panel and connect signal cable from inverter.

※※ It is possible to operate manually without connecting signal cable.

[Protective Functions] Number of blinking of Trip Lamp and cause of failure

Number of blinking of Trip Lamp	Cause of failure
1	High voltage
2	Low voltage
3	Over current (pump lock, sudden increase of current)
	Short circuit (motor or inverter)
4	Inverter (IPM) overheating
	Over current (pump overload)
5	High temperature of handling liquid
10	Inverter internal overheating

Note) Only in case of Low voltage failure, pump will try to re-start in 5 seconds after it stops. Even if there are no failure on the pump, Trip Lamp will blink twice with in terms of max. 90 seconds. This is due to discharging of capacitor of inverter and not a failure.

<Specification of signal output on failure>

Rating of contact	AC250V 1.5A※
Type of contact	Normal - open, Acting - contact

※ Model of 3.2kW(200, 220V) and below will be 0.3A

Note) In case of Low voltage (Trip Lamp blinking twice), signal will not be outputted.

[Manual Operation] Dial setting and output frequency

Dial setting	8	7	6	5	4	3	2	1	0
Output frequency (%)	100 (max.)	95	90	85	80	75	71	67 (min.)	Stop

<Regulating dial and Indication lamps>

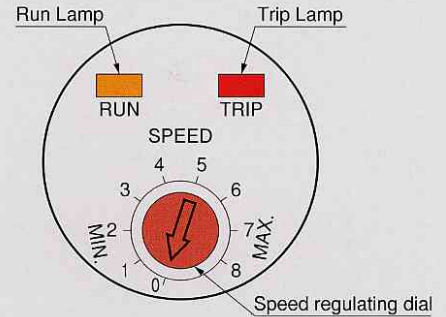

<Dial setting and pump characteristics>

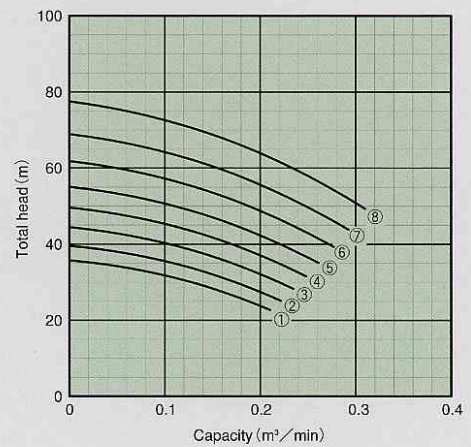

[Driven by external signal] Current signal and output frequency

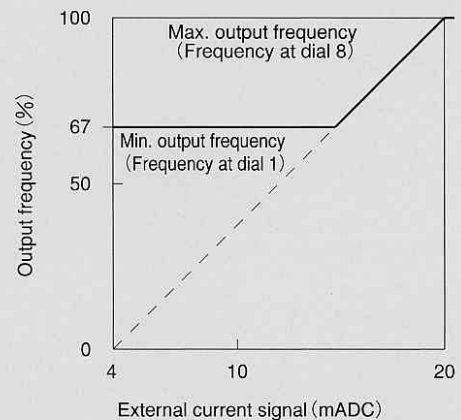

Note) Pump will be operated by external current signal regardless of dial position. If some failure occurs in circuit of signal and current signal has been disconnected, pump will operate at the speed of current dial position.

Selection Chart

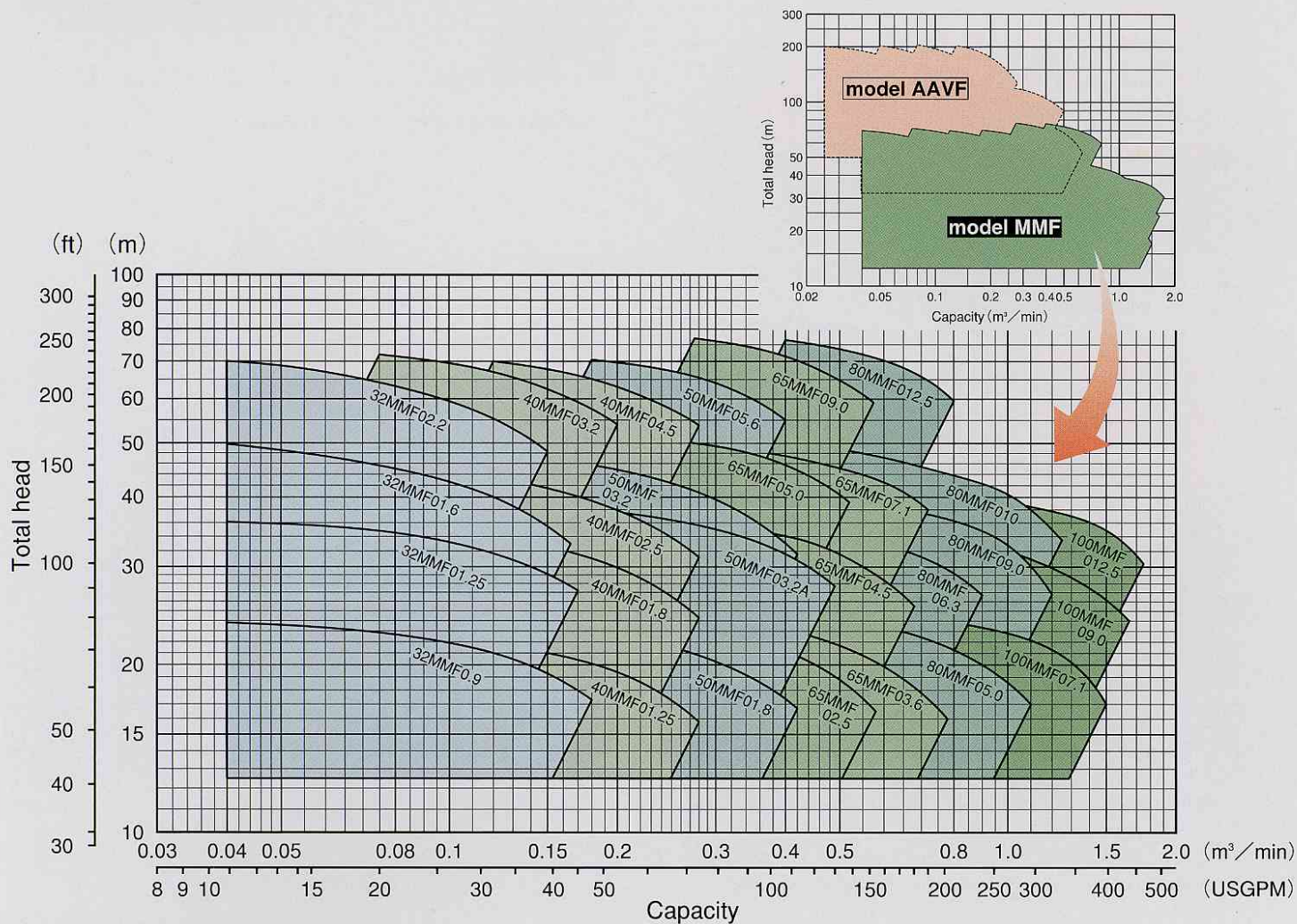

Performance

Size ϕ	Model	Output kW	Rated speed min ⁻¹	Capacity m ³ /min (USGPM)	Total head m (ft)	Max. Suction pressure MPa {kgf/cm ² }	Rated Current* A (for 200V)
32	32MMF0.9	0.9	5695	0.140 (37.9)	19.5 (64.0)	0.6 {6.1}	6.4
	32MMF01.25	1.25	7250	0.140 (37.9)	29.0 (95.1)	0.6 {6.1}	9.2
	32MMF01.6	1.6	8605	0.125 (33.0)	38.5 (126.3)	0.6 {6.1}	11.5
	32MMF02.2	2.2	10370	0.112 (29.6)	56.0 (183.7)	0.4 {4.1}	14.4
40	40MMF01.25	1.25	5095	0.225 (59.4)	17.5 (57.4)	0.6 {6.1}	8.5
	40MMF01.8	1.8	6460	0.225 (59.4)	27.5 (90.2)	0.6 {6.1}	12.5
	40MMF02.5	2.5	7100	0.200 (52.8)	37.0 (121.4)	0.6 {6.1}	15.5
	40MMF03.2	3.2	9190	0.170 (44.9)	58.0 (190.3)	0.4 {4.1}	20.0
	40MMF04.5	4.5	8100	0.240 (63.4)	57.0 (187.0)	0.4 {4.1}	25.5
50	50MMF01.8	1.8	4560	0.360 (95.1)	18.0 (59.1)	0.6 {6.1}	12.0
	50MMF03.2A	3.2	5775	0.360 (95.1)	32.0 (105.0)	0.6 {6.1}	19.5
	50MMF03.2	3.2	6450	0.320 (84.5)	37.0 (121.4)	0.6 {6.1}	20.0
	50MMF05.6	5.6	7275	0.360 (95.1)	57.0 (187.0)	0.4 {4.1}	31.5
65	65MMF02.5	2.5	4320	0.500 (132.1)	18.0 (59.1)	0.6 {6.1}	15.5
	65MMF03.6	3.6	3860	0.700 (184.9)	17.5 (57.4)	0.6 {6.1}	21.0
	65MMF04.5	4.5	5125	0.560 (148.0)	29.0 (95.1)	0.6 {6.1}	25.0
	65MMF05.0	5.0	6105	0.450 (118.9)	42.0 (137.8)	0.6 {6.1}	29.0
	65MMF07.1	7.1	5470	0.630 (166.4)	41.0 (134.5)	0.6 {6.1}	37.0
	65MMF09.0	9.0	6510	0.500 (132.1)	62.0 (203.4)	0.4 {4.1}	45.0
80	80MMF05.0	5.0	3860	0.900 (237.8)	19.5 (64.0)	0.6 {6.1}	28.0
	80MMF06.3	6.3	4590	0.750 (198.2)	29.0 (95.1)	0.6 {6.1}	35.0
	80MMF09.0	9.0	4610	1.000 (264.2)	32.0 (105.0)	0.6 {6.1}	45.0
	80MMF010	10	5185	1.000 (264.2)	40.0 (131.2)	0.6 {6.1}	46.0
	80MMF012.5	12.5	5800	0.700 (184.9)	64.0 (210.0)	0.4 {4.1}	58.0
100	100MMF07.1	7.1	3630	1.250 (330.3)	20.5 (67.3)	0.6 {6.1}	36.0
	100MMF09.0	9.0	4610	1.400 (369.9)	27.0 (88.6)	0.6 {6.1}	45.0
	100MMF012.5	12.5	5300	1.500 (396.3)	34.0 (111.6)	0.6 {6.1}	58.0

*In case of operating by power source capacity more than 500kVA, current may exceed rated value. Please use AC reactor for said application.

Performance Curves

Explanation

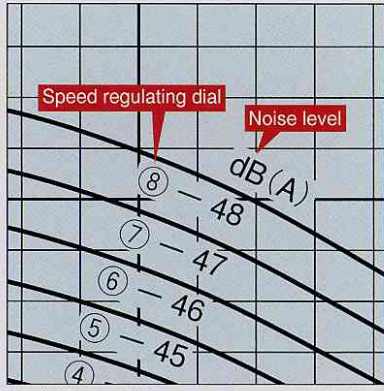

Note) Noise level in the curves shows rough noise level measured at 1m away from the pump operating at best efficiency flow rate.

1 32MMF0.9

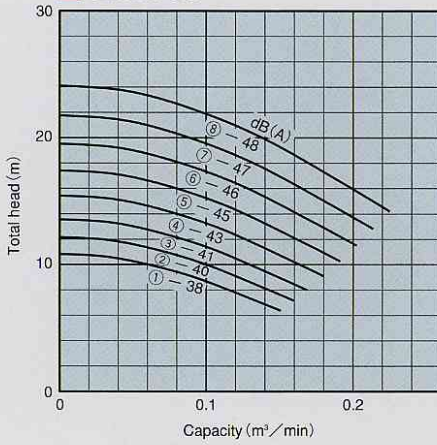

2 32MMF01.25

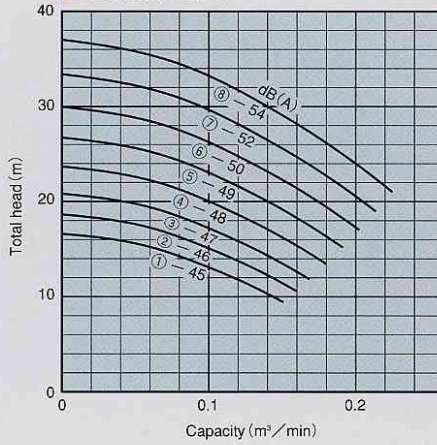

3 32MMF01.6

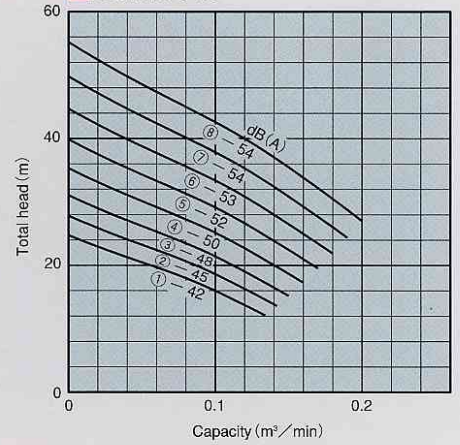

4 32MMF02.2

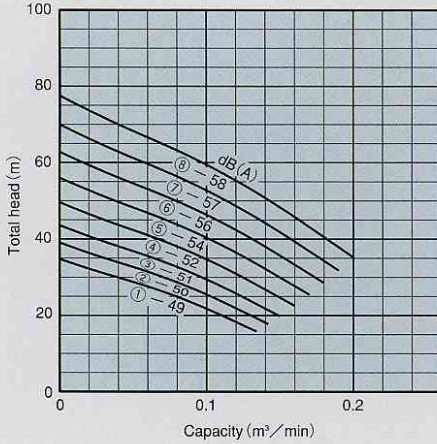

5 40MMF01.25

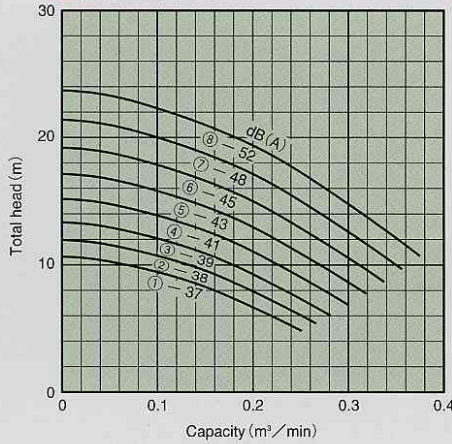

6 40MMF01.8

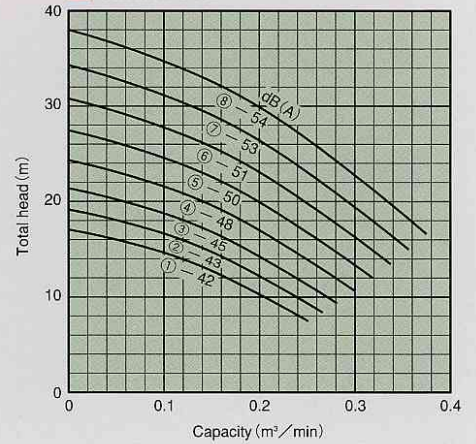

7 40MMF02.5

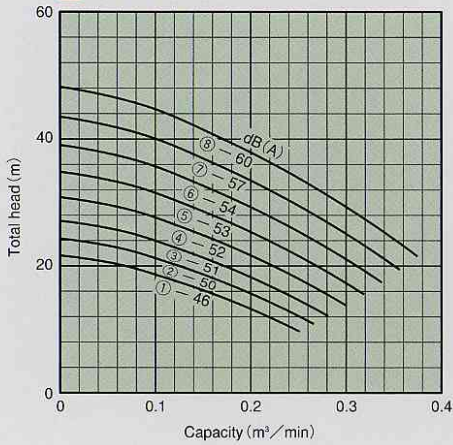

8 40MMF03.2

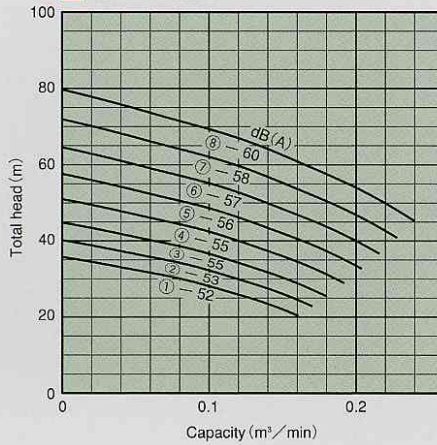

9 40MMF04.5

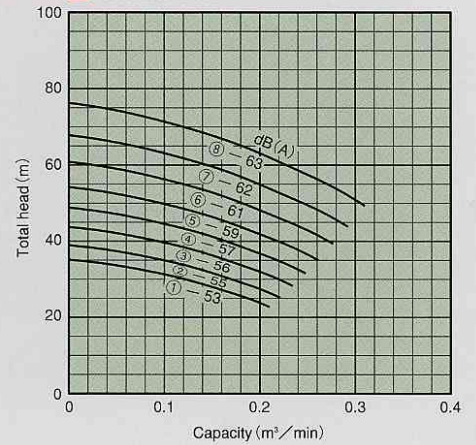

10 50MMF01.8

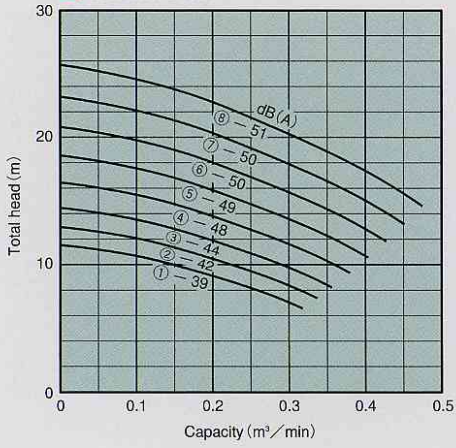

11 50MMF03.2A

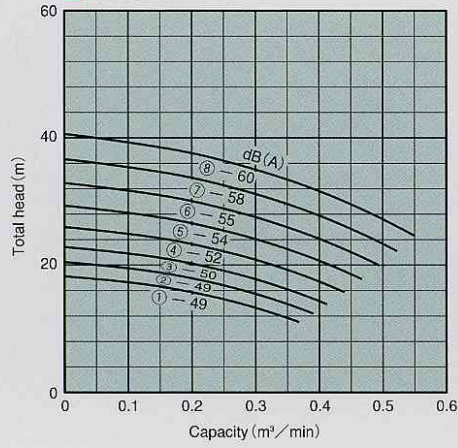

12 50MMF03.2

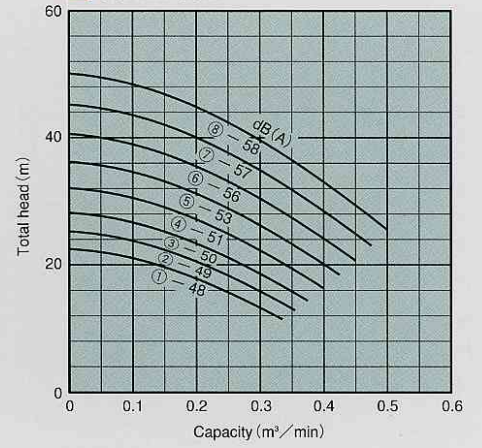

13 50MMF05.6

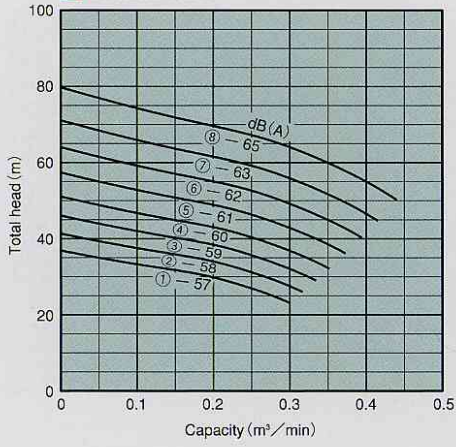

14 65MMF02.5

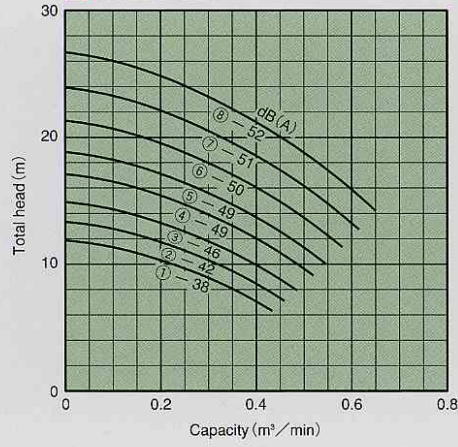

15 65MMF03.6

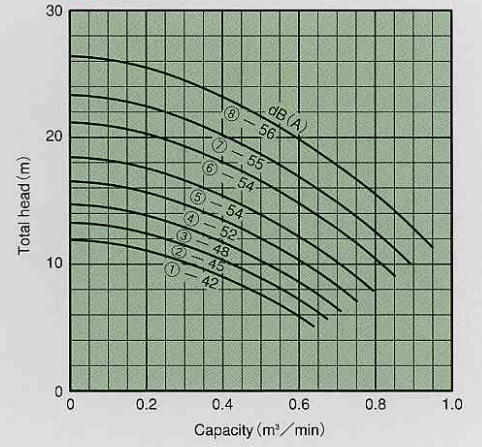

16 65MMF04.5

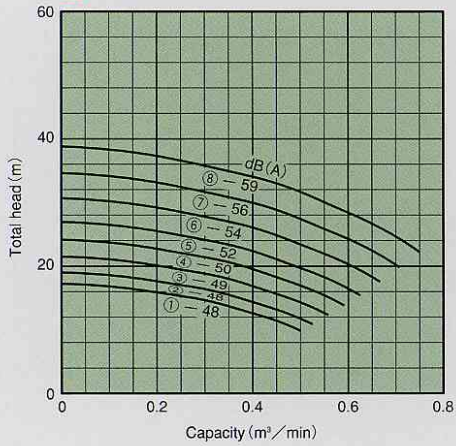

17 65MMF05.0

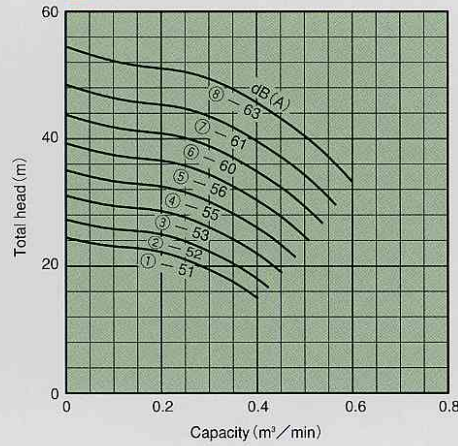

18 65MMF07.1

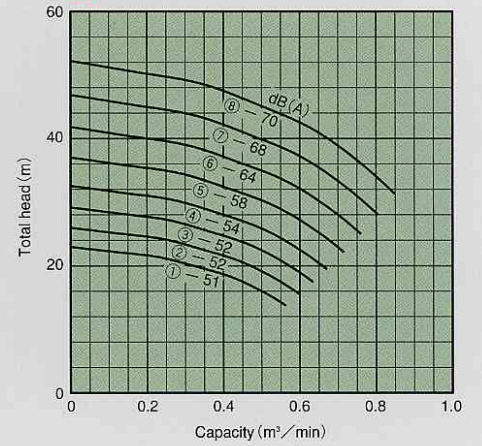

19 65MMF09.0

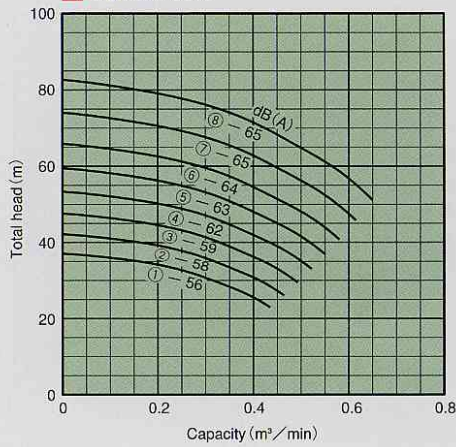

20 80MMF05.0

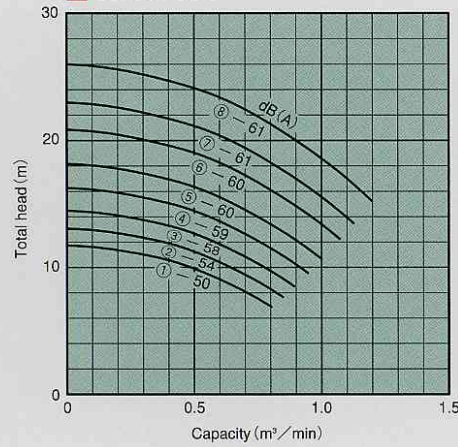

21 80MMF06.3

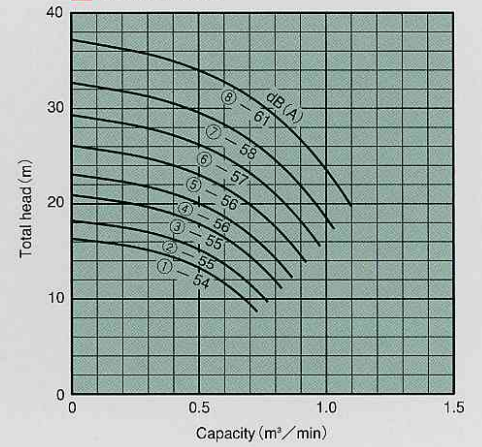

22 80MMF09.0

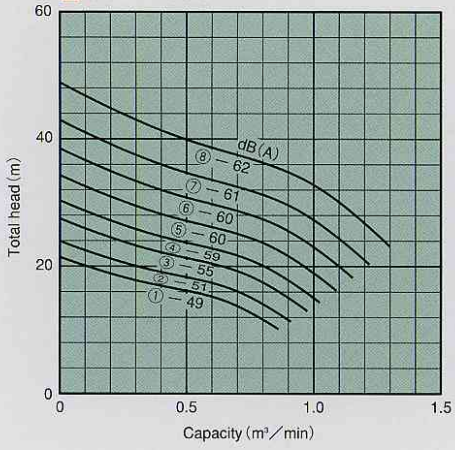

23 80MMF010

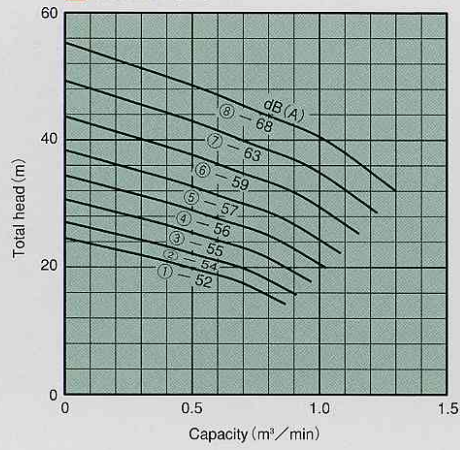

24 80MMF012.5

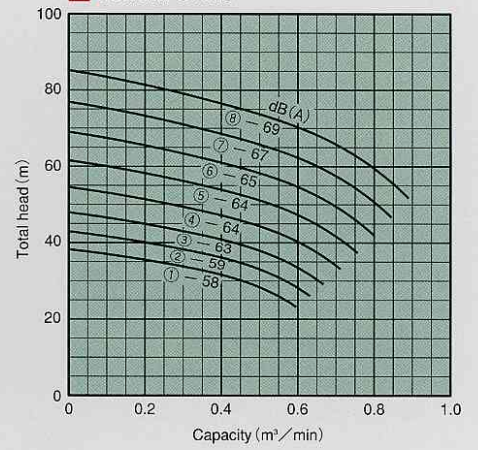

25 100MMF07.1

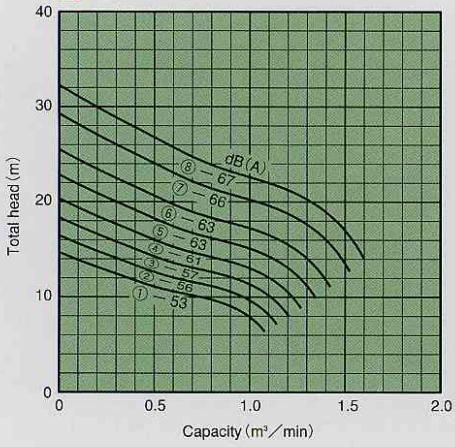

26 100MMF09.0

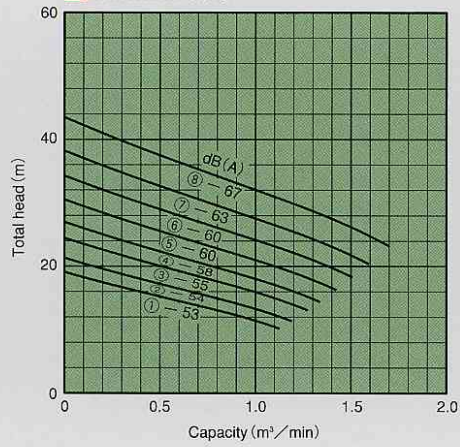

27 100MMF012.5

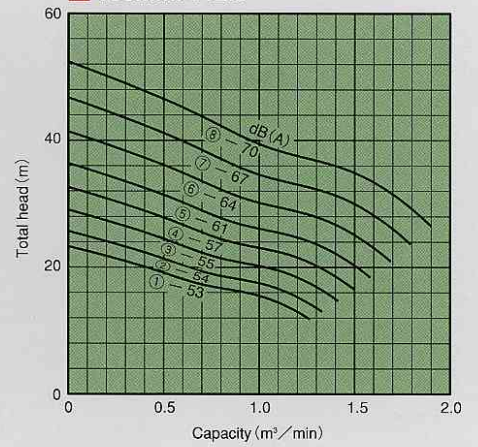

Dimensions

Size 32 · 40 · 50 (Piping supported type)

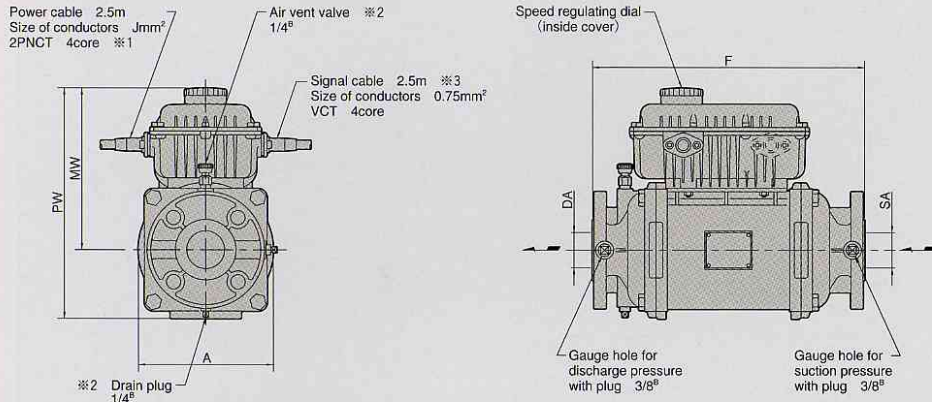

- ※ 1 . Cable with 1.25mm² conductors will be VCT instead of 2PNCT.
- ※ 2 . 50MMF05.6 will be 3/8^ø.
- ※ 3 . For 40MMF04.5 and 50MMF05.6, direction of signal cable will be same as power cable.

Size 65 · 80 · 100 (Floor installation type)

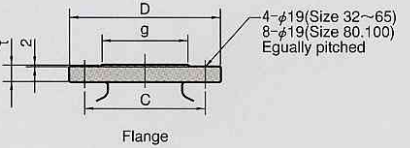
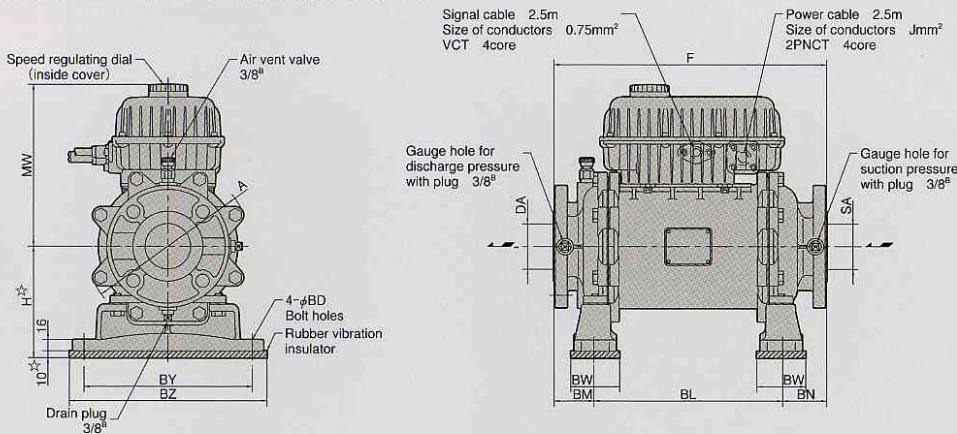

Motor specification

Three phase induction motor

Type	Canned
Pole	2
Starting method	D.O.L.(slow start)

Note) ☆show rough dimensions.

Dimension MW (PW) for size 32-50 will be changed by voltage.

Size	SA DA	Model	Output kW	Phase	Output Frequency Hz	Pump in mm				Flange in mm				Cable J	Mass kg
						A	F	MW	PW	D	C	g	t		
32		32MMF0.9	0.9	3	100	148	305	213	289	135	100	60	16	1.25	17
		32MMF01.25	1.25	3	125	148	305	213	289	135	100	60	16	1.25	17
		32MMF01.6	1.6	3	150	148	305	213	289	135	100	60	16	1.25	17
		32MMF02.2	2.2	3	180	148	315	213	289	135	100	60	16	1.25	18
40		40MMF01.25	1.25	3	90	158	330	218	299	140	105	68	17	1.25	21
		40MMF01.8	1.8	3	112	158	330	218	299	140	105	68	17	1.25	21
		40MMF02.5	2.5	3	125	158	330	218	299	140	105	68	17	1.25	21
		40MMF03.2	3.2	3	160	158	340	222	303	140	105	68	17	2	23
		40MMF04.5	4.5	3	140	178	375	225	316	140	105	68	17	3.5	32
50		50MMF01.8	1.8	3	80	178	360	217	308	155	120	80	18	2	29
		50MMF03.2A	3.2	3	100	178	360	217	308	155	120	80	18	2	29
		50MMF03.2	3.2	3	112	178	360	217	308	155	120	80	18	2	29
		50MMF05.6	5.6	3	125	235	405	233	341	155	120	80	18	5.5	50

Size	SA DA	Model	Output kW	Phase	Output Frequency Hz	Pump in mm				Base plate in mm				Flange in mm				Cable J	Mass kg			
						A	F	H*	MW	BL	BM	BN	BY	BZ	BW	BD	D			C	g	t
65		65MMF02.5	2.5	3	75	235	390	160	233	270	57	63	240	285	70	15	175	140	100	19	3.5	47
		65MMF03.6	3.6	3	67	262	435	175	245	295	67	73	255	300	70	15	175	140	100	19	5.5	60
		65MMF04.5	4.5	3	90	235	390	160	233	270	57	63	240	285	70	15	175	140	100	19	3.5	47
		65MMF05.0	5.0	3	106	235	390	160	233	270	57	63	240	285	70	15	175	140	100	19	5.5	47
		65MMF07.1	7.1	3	95	262	435	175	258	295	67	73	255	300	70	15	175	140	100	19	8	62
		65MMF09.0	9.0	3	112	262	450	175	258	310	67	73	255	300	70	15	175	140	100	19	8	65
80		80MMF05.0	5.0	3	67	262	440	175	245	295	69	76	255	300	70	15	185	150	110	20	5.5	61
		80MMF06.3	6.3	3	80	262	440	175	245	295	69	76	255	300	70	15	185	150	110	20	5.5	61
		80MMF09.0	9.0	3	80	297	485	190	272	330	75	80	290	340	80	19	185	150	110	20	8	84
		80MMF010	10	3	90	297	485	190	272	330	75	80	290	340	80	19	185	150	110	20	14	84
		80MMF012.5	12.5	3	100	297	500	190	272	345	75	80	290	340	80	19	185	150	110	20	14	87
100		100MMF07.1	7.1	3	63	297	505	190	272	330	85	90	290	340	80	19	210	175	135	21	8	86
		100MMF09.0	9.0	3	80	297	505	190	272	330	85	90	290	340	80	19	210	175	135	21	8	86
		100MMF012.5	12.5	3	90	297	505	190	272	330	85	90	290	340	80	19	210	175	135	21	14	87

Instructions for Planning and Use

Instructions for Planning

- For customers purchasing the standard pump, please refer to the standard specification. Changes can be made to the specifications depending on customer requests. Please do not operate the equipment under conditions that deviate from the specifications.
- Pumps cannot be used for sanitary application.
- Equipment for short circuit protection should be installed and spare pump should be prepared when pumps are used for facilities such as fish breeding stations, fish preserves, aquariums.
- Spare pump should be prepared in case of emergency when used for vital equipment such as computer cooling equipment, freezer cooling installation.
- Flushing must be done to prevent mixing liquid being pumped with coolant and other materials which were used when manufacturing the pumps.

Pump Operation without Water

Please prime the water before connecting the line from power source to the motor. The motor can be damaged when the pump runs without water inside. It is important to remove the air from inside the pump when testing the pump after cleaning the tank or after conducting maintenance.

Shut-Off Operation

Shut-off operation must be stopped within 30 seconds. When shut-off operation continues more than 30 seconds, the water temperature inside the pump may rise, causing motor damage.

Phase Advance Capacitor

Please do not install a phase advance capacitor to improve the power factor. The harmonics in current flow may negatively affect the capacitor in such a case.

Cavitation / Air Lock

Please do not run the pump if there is cavitation due to strainer clogging, or an airlock due to low water levels in the tank. If cavitation or air lock occurs, the pump will not be able to lift the water, and the motor may be damaged. This is explained further in the installation drawing (water level condition at the suction-side).

Thermal Relay

Motor overload protection will be done by over-current protection provided for the manual inverter. Because of this, it is possible to operate the pump even though there is no thermal relay in the control panel.

Installation of AC Reactor

Please install the AC reactor (optional accessory) under the following conditions:

- (1) When power factor improvements are required.
- (2) When capacity of power supply is 500 KVA or over.
- (3) When thyristor transfer system controller unit has been installed in the same system.
- (4) When large capacity inverter or the source of distorted waves like arc furnace are installed in the same system.
- (5) When countermeasures against harmonics are required.

Selection of the Short Circuit Breaker

Short current occurs because the inverter is installed in the pump. Please choose a short circuit breaker that is not affected by harmonics. Also, ensure that the current rating of the short circuit breaker is at least 1.6 times the pump's

current rating.
(Please consult the specifications provided by the manufacturer of the short circuit breaker for details)

Noise Reduction

The following steps are necessary if the pump is operated near the equipment sensitive to noise:

- Please wire the power cable and signal cable as far apart as possible to prevent malfunctions.
- Please install noise filters.
- Cables must be shielded by a metal conduit pipe and grounded.
- If the signal cable is extended, it should be shielded by a metal conduit pipe (Max. length of cable is 10m)

Private Power Generators

When the inverter is run by a power generator, the harmonics of inverter input may induce current flow in the generator's winding (damper winding) and cause the rising of heat. The following countermeasures are necessary when the pump is run by a generator:

- Install the AC reactor.
- Ensure that the capacity of generator (KVA) is at least three times that of the pump's rating.

Power Source Imbalance

A minor phase voltage imbalance can result in a large current imbalance because of the capacitor circuit on the inverter input side. Please check that the power source meets the following specifications:

- Normal operation: phase voltage imbalance is within 3 percent
- With AC Reactor: phase voltage imbalance is within 5 percent

Installation & required water level

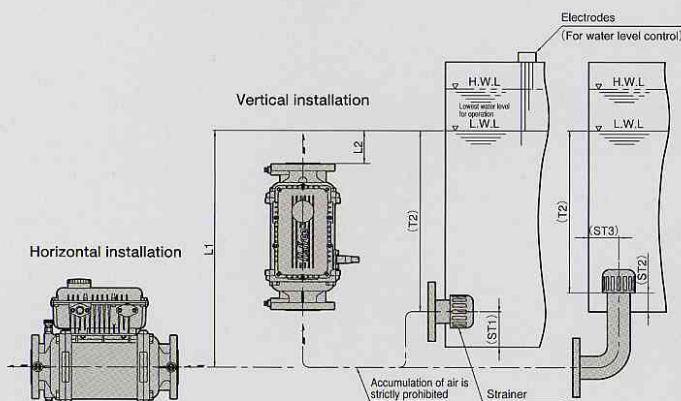

Unit : mm

Size	Model	Pump	Piping dimensions [min. value]						
		F	L1	L2	T1	T2	ST1	ST2	ST3
32	32MMF0.9	305	200	100	200	300	80	50	50
	32MMF0.1.25	305	200	100	200	300	80	50	50
	32MMF0.1.6	305	200	100	200	300	80	50	50
	32MMF0.2.2	315	200	100	200	300	80	50	50
40	40MMF0.1.25	330	250	110	250	350	90	50	60
	40MMF0.1.8	330	250	110	250	350	90	50	60
	40MMF0.2.5	330	250	110	250	350	90	50	60
	40MMF0.3.2	340	250	110	250	350	90	50	60
50	40MMF0.4.5	375	250	110	250	350	90	50	60
	50MMF0.1.8	360	300	120	300	450	100	50	80
	50MMF0.3.2A	360	300	120	300	450	100	50	80
	50MMF0.3.2	360	300	120	300	450	100	50	80
65	50MMF0.5.6	405	300	120	300	450	100	50	80
	65MMF0.2.5	390	350	—	350	550	120	70	100
	65MMF0.3.6	435	350	—	350	550	120	70	100
	65MMF0.4.5	390	350	—	350	550	120	70	100
	65MMF0.5.0	390	350	—	350	550	120	70	100
	65MMF0.7.1	435	350	—	350	550	120	70	100
80	65MMF0.9.0	450	350	—	350	550	120	70	100
	80MMF0.5.0	440	400	—	400	650	130	80	120
	80MMF0.6.3	440	400	—	400	650	130	80	120
	80MMF0.9.0	485	400	—	400	650	130	80	120
	80MMF0.1.0	485	400	—	400	650	130	80	120
100	80MMF0.12.5	500	400	—	400	650	130	80	120
	100MMF0.7.1	505	450	—	450	800	150	100	150
	100MMF0.9.0	505	450	—	450	800	150	100	150
	100MMF0.12.5	505	450	—	450	800	150	100	150

