

# LPC - LPCD

## IN-LINE CENTRIFUGAL ELECTRIC PUMPS

in cast iron



In-Line centrifugal electric pumps with cast iron hydraulic parts.

### APPLICATIONS

- Handling liquids in civil and industrial circulation, heating and air conditioning systems
- Moving domestic hot water and low pressure liquids in general
- Cooling and air conditioning plants

### TECHNICAL DETAILS

- Versatile
- Silent

### TECHNICAL DATA

- Maximum working pressure:
  - 6 bar for LPC 32-100 and LPC 40-100
  - 10 bar for the rest of the range
- Maximum temperature of the liquid:
  - from -10°C to +60°C for LPC 32-100
  - from -10°C to +130°C for the rest of the range
- Maximum environment temperature: +40°C (over, request verification)
- Maximum viscosity of the liquid conveyed: 5°E
- Self-ventilated 2 and 4 pole asynchronous motor
- Class of insulation F
- IP 55 protection rating
- 230/400V ±10%, 50 Hz three phase voltage, up to 4 kW, 400/690V ±10%, 50 Hz 5.5 kW and over
- Protection under user's responsibility for the three phase version
- Flanges: PN6 for LPC 32-100 and LPC 40-100, UNI2223-29 PN16 for the rest of the range

### MATERIALS

- Pump body, seal housing disc, shield, lantern and cover in cast iron
- Impeller in technopolymer for LPC 32-100, in cast iron for the rest of the range
- Shaft in AISI 420
- Mechanical seal in Carbon/SiC/EPDM (SiC/SiC/EPDM optional)

### ACCESSORIES (on request)

- Galvanised counter-flanges kit

### IDENTIFICATION CODE

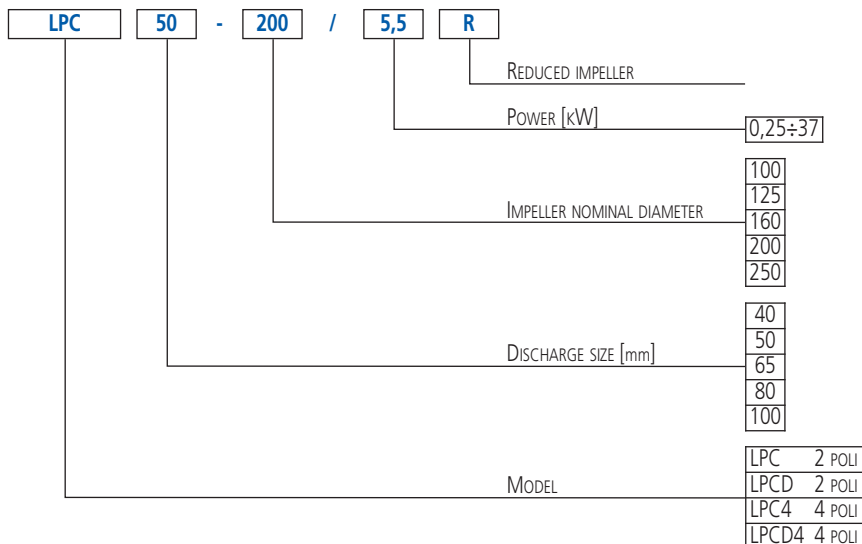

# LPC - LPCD

## IN-LINE CENTRIFUGAL ELECTRIC PUMPS

in cast iron

### LPC range PERFORMANCE RANGE

(according to ISO 9906 Attachment A)

### 2 Poles

### LPCD range PERFORMANCE RANGE

(according to ISO 9906 Attachment A)

### 2 Poles

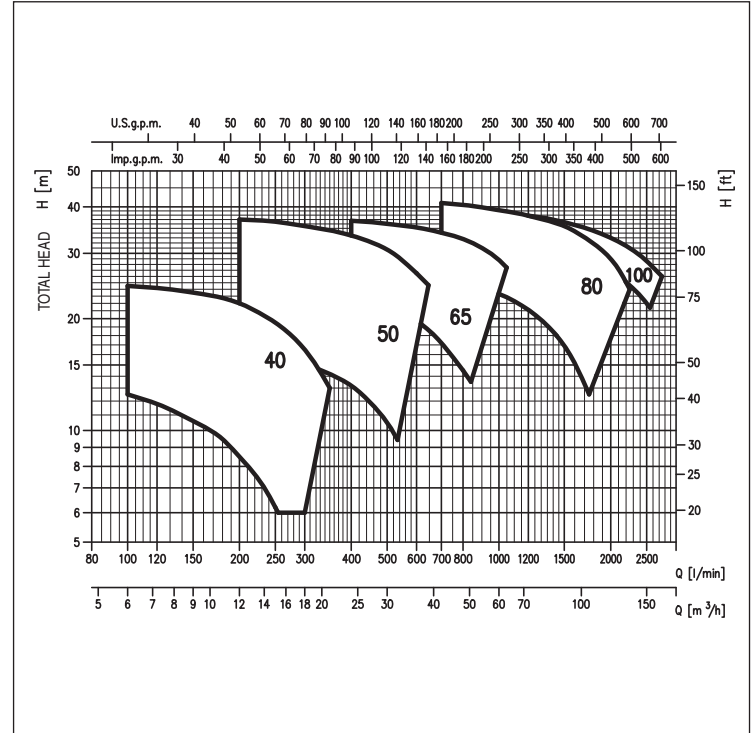
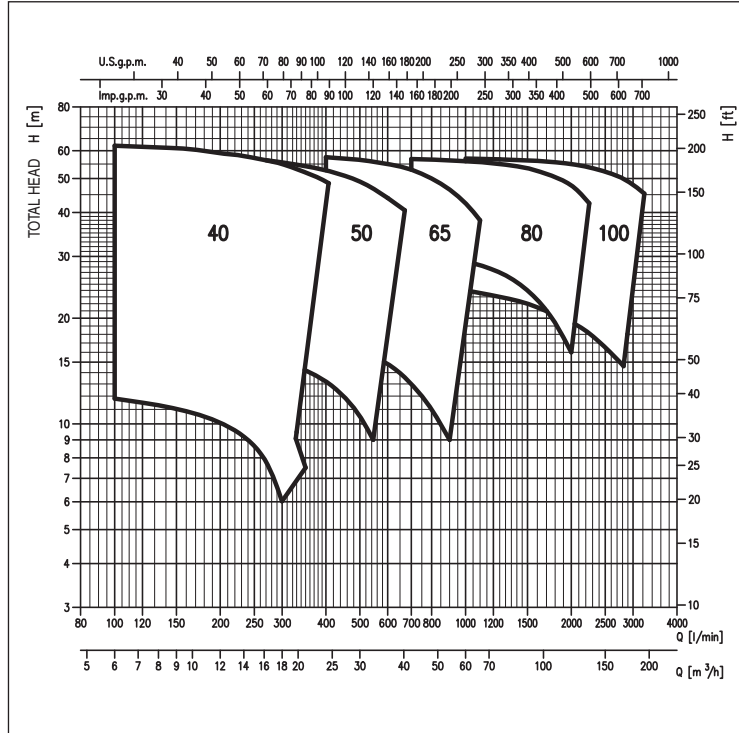

### LPC4 \* range PERFORMANCE RANGE

(according to ISO 9906 Attachment A)

### 4 Poles

### LPCD4 range PERFORMANCE RANGE

(according to ISO 9906 Attachment A)

### 4 Poles

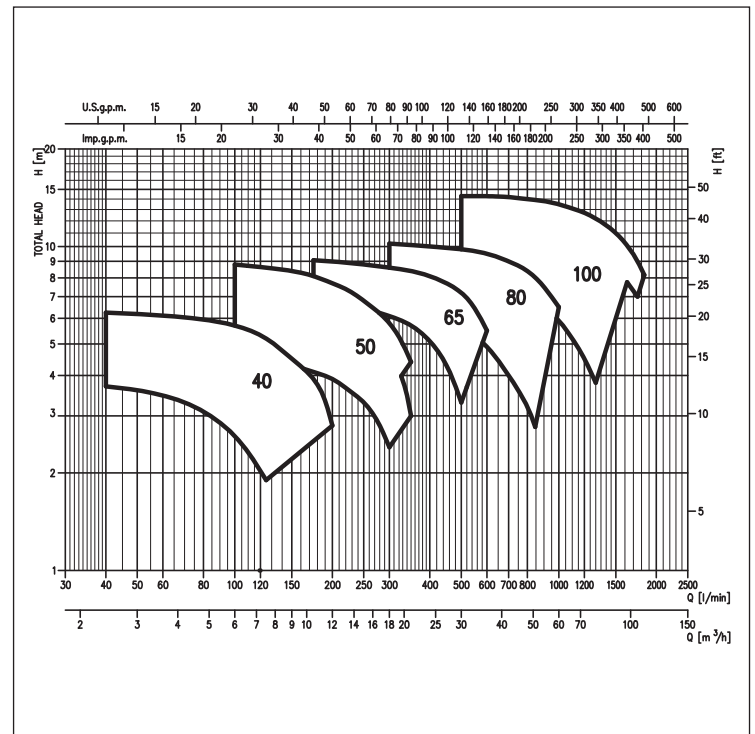
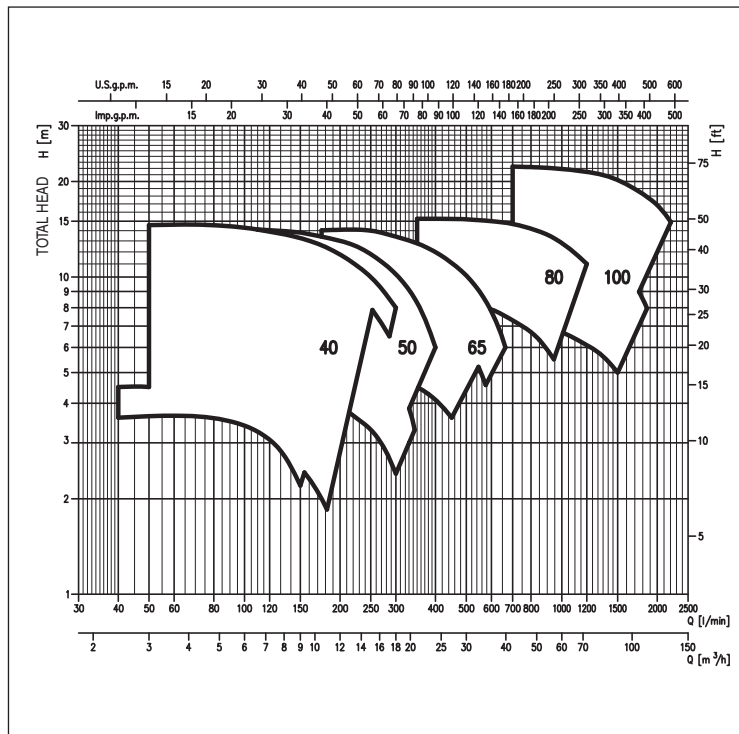

\* Wide range available (see following tables for performance data)

Data under revision. For more information please contact our sales network.





# LPC - LPCD

## IN-LINE CENTRIFUGAL ELECTRIC PUMPS

in cast iron

LPCD PERFORMANCE TABLE

2 Poles

Three phase Model 230/400/690V	P <sub>2</sub>		Q=Flow rate																											
	[HP]	[kW]	l/min	6	7,5	9	10,5	12	13,5	15	18	21	24	27	30	36	42	48	54	60	75	90	105	120	135	165	180	195	210	225
			m <sup>3</sup> /h	100	125	150	175	200	225	250	300	350	400	450	500	600	700	800	900	1000	1250	1500	1750	2000	2250	2750	3000	3250	3500	3750
				H=Head [m]																										
LPCD 40-125/0,55	0,75	0,55	12,5	11,6	10,6	9,7	8,5	7,4	6,2	-	-	-	-	-	-	-	-	-	-	-	-	-	-	-	-	-	-	-	-	-
LPCD 40-125/0,75	1	0,75	15,3	14,5	13,7	12,8	11,5	10,4	9,0	6,0	-	-	-	-	-	-	-	-	-	-	-	-	-	-	-	-	-	-	-	-
LPCD 40-125/1	1,5	1,1	20,5	19,7	19,0	18,1	17,1	15,9	14,5	11,2	7,5	-	-	-	-	-	-	-	-	-	-	-	-	-	-	-	-	-	-	-
LPCD 40-125/1,5	2	1,5	24,5	24,1	23,5	22,9	22,0	20,8	19,5	16,5	13,0	-	-	-	-	-	-	-	-	-	-	-	-	-	-	-	-	-	-	-
LPCD 50-125/1,5	2	1,5	-	-	-	-	16,0	15,7	15,5	15,0	14,2	13,2	11,9	10,5	7,0	-	-	-	-	-	-	-	-	-	-	-	-	-	-	-
LPCD 50-125/2	3	2,2	-	-	-	-	19,5	19,3	19,1	18,5	17,5	16,6	15,5	14,1	10,5	-	-	-	-	-	-	-	-	-	-	-	-	-	-	-
LPCD 50-125/3	4	3	-	-	-	-	24,7	24,6	24,5	24,2	23,7	23,0	21,8	20,5	17,0	-	-	-	-	-	-	-	-	-	-	-	-	-	-	-
LPCD 50-160/3	4	3	-	-	-	-	30,5	30,2	29,9	29,0	27,8	26,5	24,9	23,0	18,0	-	-	-	-	-	-	-	-	-	-	-	-	-	-	-
LPCD 50-160/4	5,5	4	-	-	-	-	37,0	36,8	36,5	35,5	34,6	33,5	32,2	30,7	26,5	-	-	-	-	-	-	-	-	-	-	-	-	-	-	-
LPCD 65-160/3	4	3	-	-	-	-	-	-	-	-	23,0	22,5	22,0	21,3	19,7	17,2	14,5	-	-	-	-	-	-	-	-	-	-	-	-	-
LPCD 65-160/4	5,5	4	-	-	-	-	-	-	-	-	27,0	26,6	26,0	25,5	24,2	22,5	20,2	16,8	-	-	-	-	-	-	-	-	-	-	-	-
LPCD 65-160/5,5	7,5	5,5	-	-	-	-	-	-	-	-	32,3	32,0	31,5	30,8	29,5	28,0	25,8	23,5	-	-	-	-	-	-	-	-	-	-	-	-
LPCD 65-160/7,5	10	7,5	-	-	-	-	-	-	-	-	36,7	36,4	36,0	35,2	34,1	32,8	31,0	28,8	-	-	-	-	-	-	-	-	-	-	-	-
LPCD 80-160/7,5	10	7,5	-	-	-	-	-	-	-	-	-	-	-	-	25,5	25,2	24,7	24,0	23,3	20,5	16,9	12,5	-	-	-	-	-	-	-	-
LPCD 80-160/10	13,6	10	-	-	-	-	-	-	-	-	-	-	-	-	-	30,5	30,0	29,5	29,0	27,0	24,0	20,2	16,0	-	-	-	-	-	-	-
LPCD 80-160/12,5	17	12,5	-	-	-	-	-	-	-	-	-	-	-	-	-	36,0	35,5	35,0	34,5	32,8	30,0	27,0	23,0	19,0	-	-	-	-	-	-
LPCD 80-160/15	20	15	-	-	-	-	-	-	-	-	-	-	-	-	-	41,0	40,5	39,9	39,2	37,5	35,5	32,5	29,0	24,0	-	-	-	-	-	-
LPCD 100-200/10	13,5	10	-	-	-	-	-	-	-	-	-	-	-	-	-	-	-	-	24,5	23,5	22,0	20,5	18,5	16,0	10,5	7,0	3,0	-	-	-
LPCD 100-200/12,5 R	17	12,5	-	-	-	-	-	-	-	-	-	-	-	-	-	-	-	-	33,0	32,5	31,0	29,0	27,0	24,5	19,0	-	-	-	-	-
LPCD 100-200/12,5	17	12,5	-	-	-	-	-	-	-	-	-	-	-	-	-	-	-	-	27,5	26,5	25,5	24,0	22,0	20,0	15,0	12,0	8,6	5,0	-	-
LPCD 100-200/15 R	20	15	-	-	-	-	-	-	-	-	-	-	-	-	-	-	-	-	-	37,5	36,5	35,0	33,0	31,0	26,0	-	-	-	-	-
LPCD 100-200/15	20	15	-	-	-	-	-	-	-	-	-	-	-	-	-	-	-	-	-	28,0	27,0	25,5	23,5	21,5	16,5	13,8	10,8	7,5	3,0	-

LPCD4 PERFORMANCE TABLE

4 Poles

Three phase Model 230/400/690V	P <sub>2</sub>		Q=Flow rate																											
	[HP]	[kW]	l/min	0	2,4	3	4,5	6	7,5	9	10,5	12	13,5	15	18	21	24	27	30	36	42	48	54	60	66	72	78	90	105	120
			m <sup>3</sup> /h	0	40	50	75	100	125	150	175	200	225	250	300	350	400	450	500	600	700	800	900	1000	1100	1200	1300	1500	1750	2000
				H=Head [m]																										
LPCD4 40-100/0,25	0,33	0,25	4,0	3,7	3,6	3,1	2,6	1,9	-	-	-	-	-	-	-	-	-	-	-	-	-	-	-	-	-	-	-	-	-	-
LPCD4 40-125/0,25 R	0,33	0,25	4,8	4,5	4,4	4,1	3,7	3,0	2,2	-	-	-	-	-	-	-	-	-	-	-	-	-	-	-	-	-	-	-	-	-
LPCD4 40-125/0,25	0,33	0,25	6,3	-	6,2	6,0	5,7	5,2	4,5	3,9	2,8	-	-	-	-	-	-	-	-	-	-	-	-	-	-	-	-	-	-	-
LPCD4 50-125/0,25	0,33	0,25	4,8	-	-	-	4,6	4,5	4,3	4,1	3,9	3,6	3,3	2,4	-	-	-	-	-	-	-	-	-	-	-	-	-	-	-	-
LPCD4 50-125/0,37	0,5	0,37	6,4	-	-	-	6,3	6,2	6,1	6,0	5,8	5,6	5,3	4,6	3,0	-	-	-	-	-	-	-	-	-	-	-	-	-	-	-
LPCD4 50-160/0,5	0,7	0,5	9,2	-	-	-	8,8	8,6	8,4	8,1	7,7	7,3	6,8	5,8	4,4	-	-	-	-	-	-	-	-	-	-	-	-	-	-	-
LPCD4 65-160/0,55	0,75	0,55	6,9	-	-	-	-	-	6,8	6,7	6,6	6,5	6,4	6,1	5,7	5,1	4,3	3,3	-	-	-	-	-	-	-	-	-	-	-	-
LPCD4 65-160/0,75	1	0,75	8,3	-	-	-	-	-	-	-	8,1	8,0	7,9	7,8	7,4	7,0	6,6	6,0	4,0	-	-	-	-	-	-	-	-	-	-	-
LPCD4 65-160/0,9	1,25	0,9	9,1	-	-	-	-	-	-	-	9,0	8,9	8,8	8,7	8,4	8,1	7,7	7,2	5,5	-	-	-	-	-	-	-	-	-	-	-
LPCD4 80-160/0,75	1	0,75	6,4	-	-	-	-	-	-	-	-	-	-	6,3	6,1	6,0	5,8	5,6	4,9	4,0	3,2	2,2	-	-	-	-	-	-	-	-
LPCD4 80-160/0,9	1,25	0,9	7,4	-	-	-	-	-	-	-	-	-	-	7,3	7,2	7,1	7,0	6,8	6,3	5,6	4,8	3,8	-	-	-	-	-	-	-	-
LPCD4 80-160/1,1	1,5	1,1	8,6	-	-	-	-	-	-	-	-	-	-	8,5	8,5	8,4	8,3	8,2	7,9	7,3	6,7	5,9	5,0	-	-	-	-	-	-	-
LPCD4 80-160/1,5	2	1,5	10,3	-	-	-	-	-	-	-	-	-	-	10,2	10,1	10,0	9,9	9,8	9,5	9,0	8,4	7,5	6,5	-	-	-	-	-	-	-
LPCD4 100-200/1,5	2	1,5	8,6	-	-	-	-	-	-	-	-	-	-	-	-	-	-	8,1	7,8	7,4	7,0	6,5	5,9	5,2	4,5	3,8	-	-	-	-
LPCD4 100-200/2,2	3	2,2	10,6	-	-	-	-	-	-	-	-	-	-	-	-	-	-	10,2	10,0	9,7	9,3	9,0	8,6	8,2	7,7	7,2	6,0	-	-	-
LPCD4 100-200/3	4	3	12,7	-	-	-	-	-	-	-	-	-	-	-	-	-	-	-	12,0	11,8	11,5	11,3	10,9	10,5	10,0	9,5	8,5	7,0	-	-
LPCD4 100-200/4	5,5	4	14,9	-	-	-	-	-	-	-	-	-	-	-	-	-	-	-	14,3	14,2	14,0	13,8	13,4	13,1	12,7	12,2	11,0	9,0	6,5	-

AUTOMATIC FUNCTIONING OF THE NON-RETURN VALVE

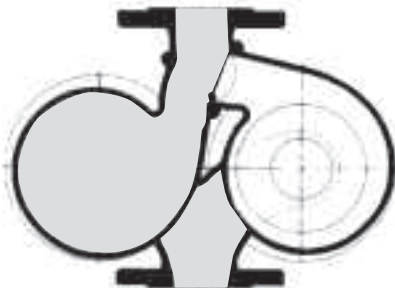

LEFT PUMP RUNNING

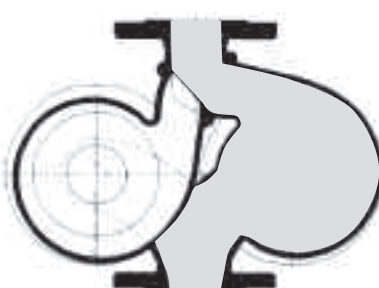

RIGHT PUMP RUNNING

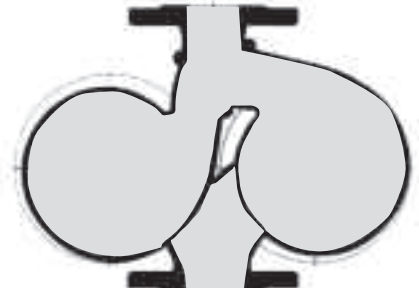

PARALLEL RUNNING



# LPC - LPCD

## IN-LINE CENTRIFUGAL ELECTRIC PUMPS

in cast iron

### LPC 40-100 range PERFORMANCE CURVES

(according to ISO 9906 Attachment A)

2 Poles

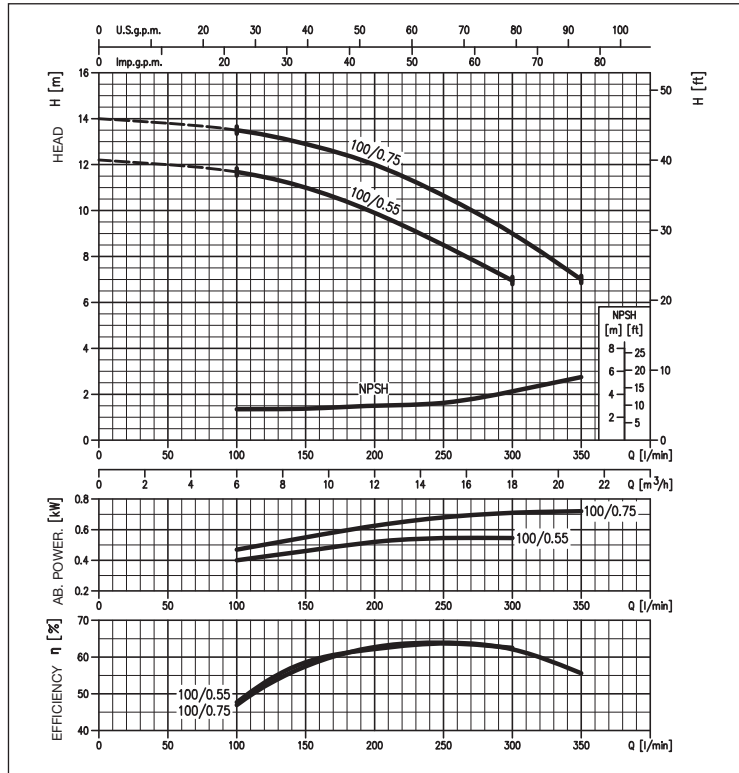

### LPC 40-125 range PERFORMANCE CURVES

(according to ISO 9906 Attachment A)

2 Poles

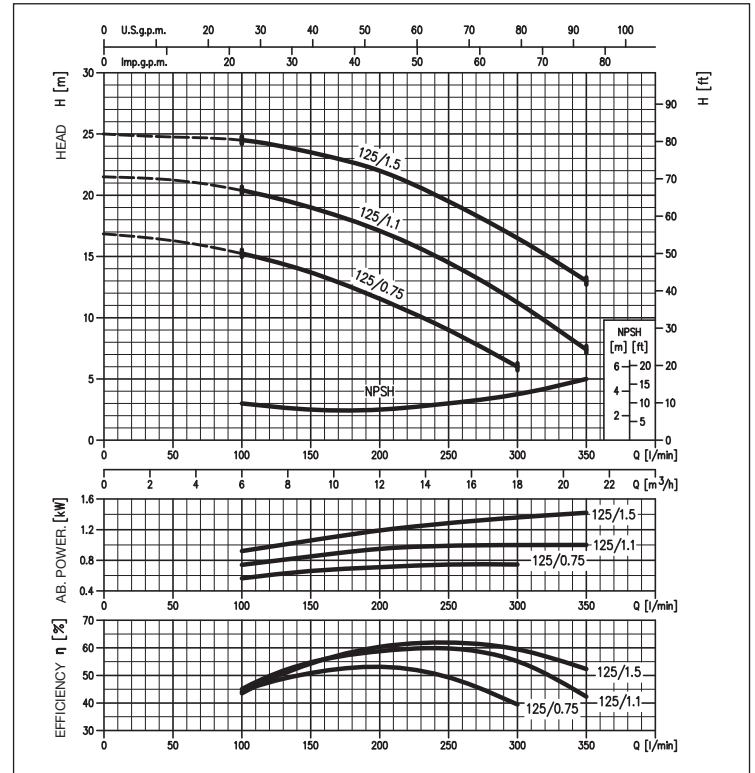

### LPC 40-160 range PERFORMANCE CURVES

(according to ISO 9906 Attachment A)

2 Poles

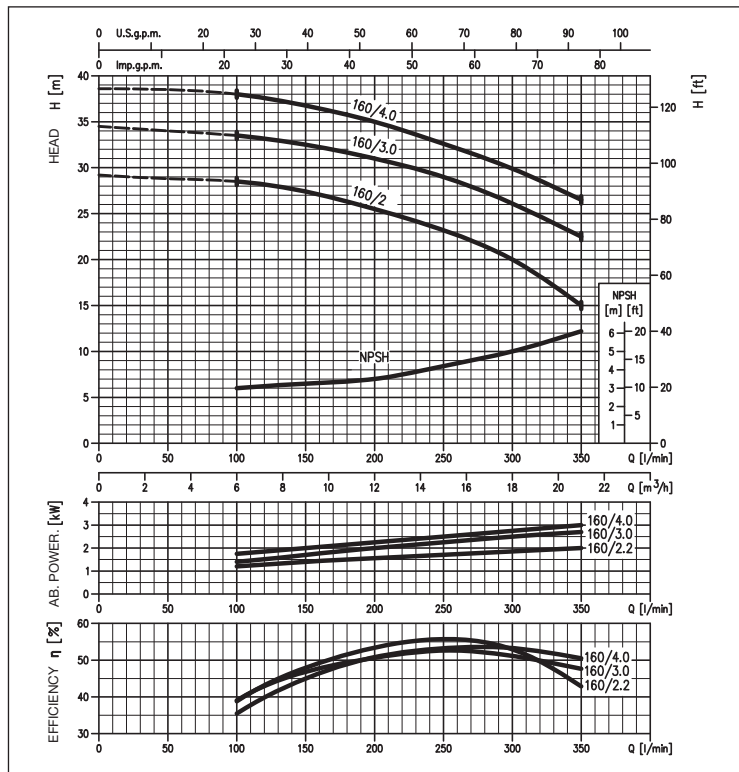

### LPC 40-200 range PERFORMANCE CURVES

(according to ISO 9906 Attachment A)

2 Poles

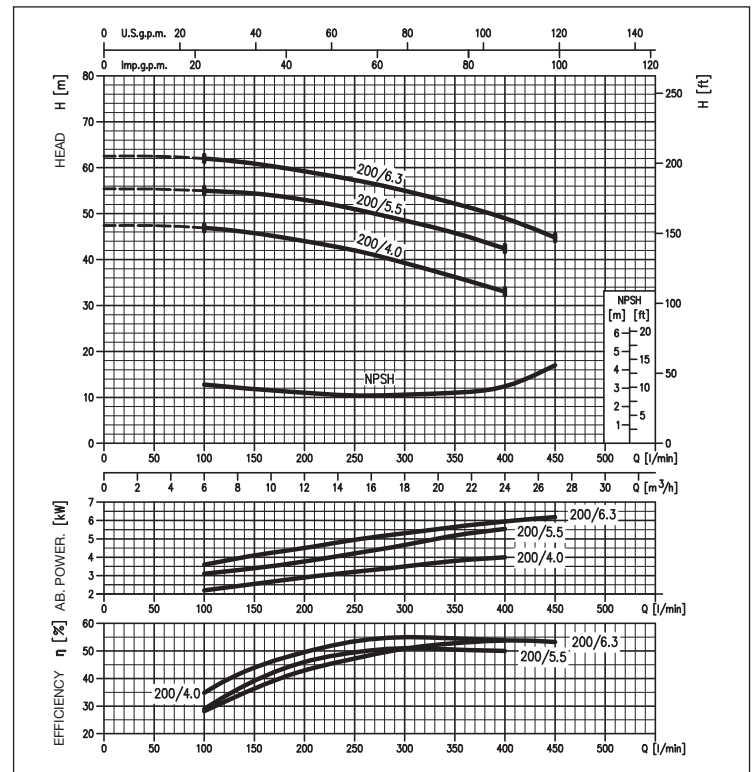



## IN-LINE CENTRIFUGAL ELECTRIC PUMPS

in cast iron

### LPC 50-125 range PERFORMANCE CURVES

(according to ISO 9906 Attachment A)

2 Poles

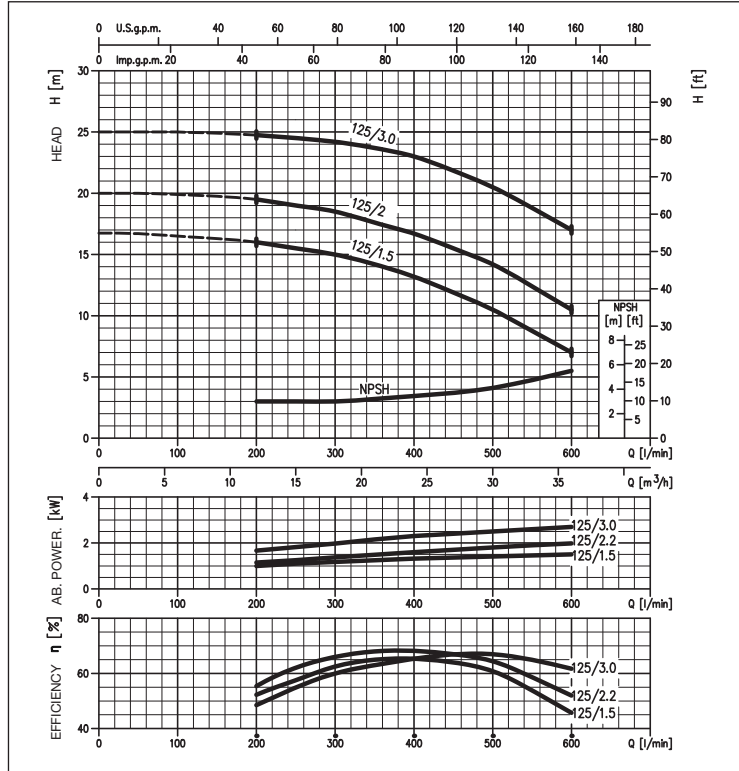

### LPC 50-160 range PERFORMANCE CURVES

(according to ISO 9906 Attachment A)

2 Poles

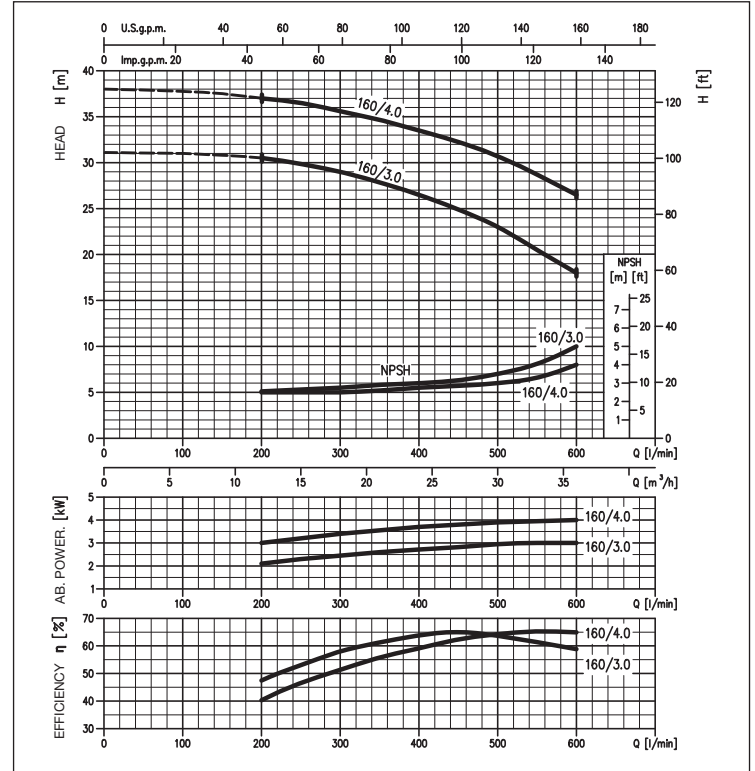

### LPC 50-200 range PERFORMANCE CURVES

(according to ISO 9906 Attachment A)

2 Poles

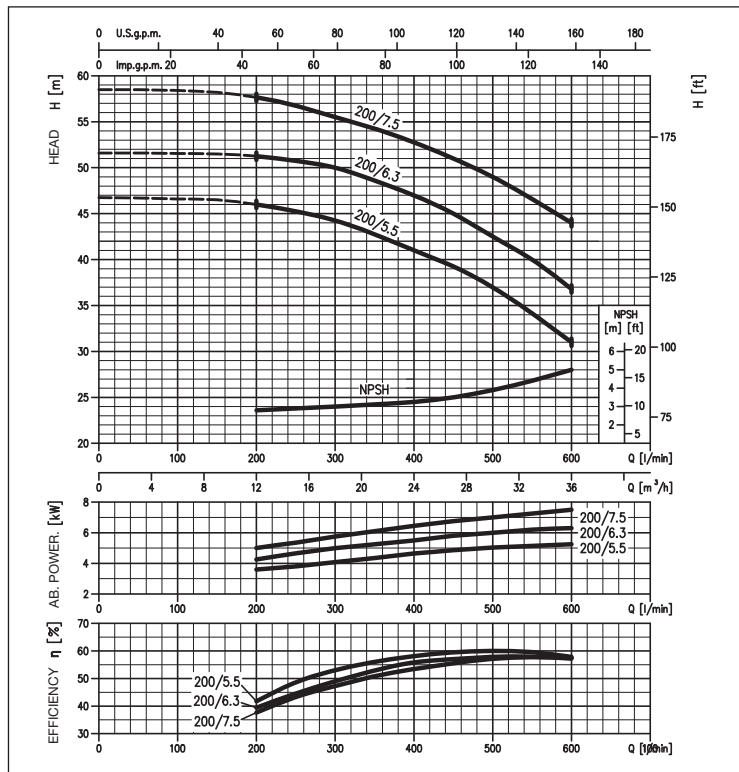

### LPC 65-125 range PERFORMANCE CURVES

(according to ISO 9906 Attachment A)

2 Poles

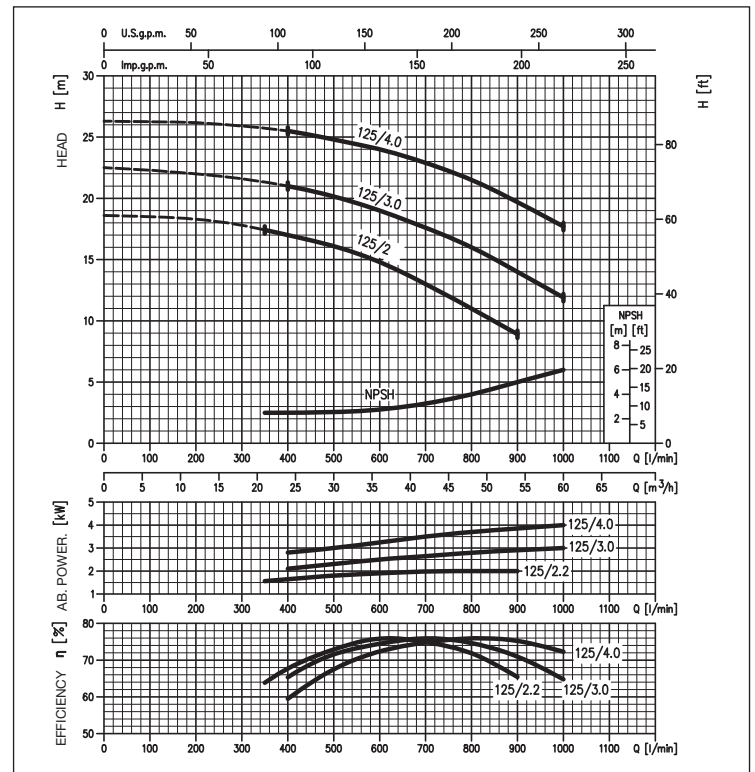

# LPC - LPCD

## IN-LINE CENTRIFUGAL ELECTRIC PUMPS

in cast iron

### LPC 65-160 range PERFORMANCE CURVES

(according to ISO 9906 Attachment A)

2 Poles

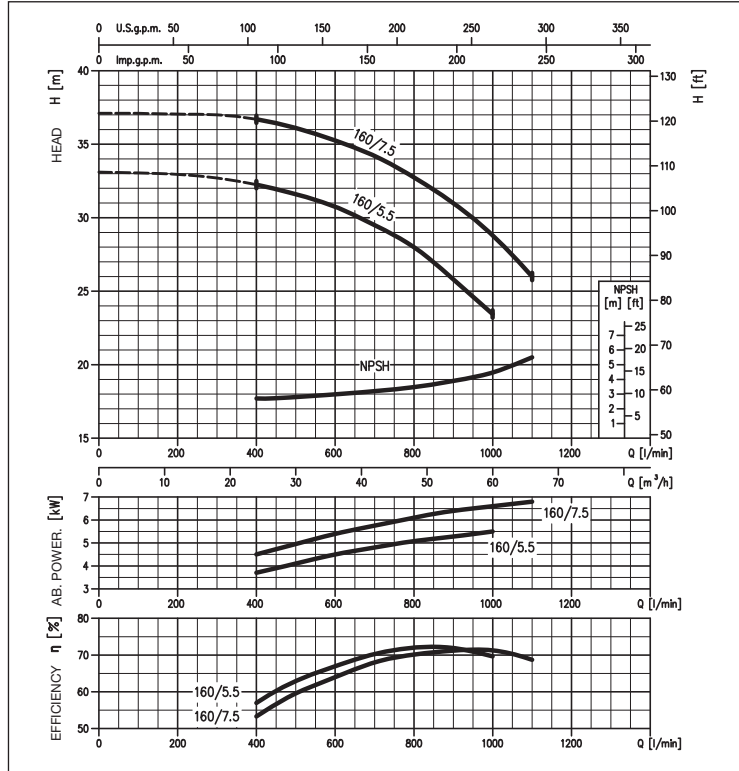

### LPC 65-200 range PERFORMANCE CURVES

(according to ISO 9906 Attachment A)

2 Poles

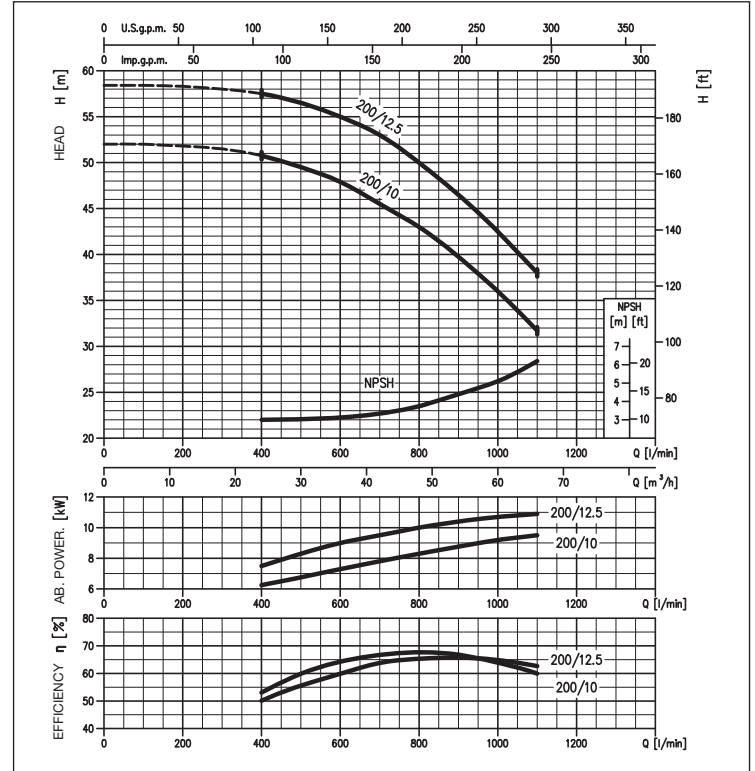

### LPC 80-160 range PERFORMANCE CURVES

(according to ISO 9906 Attachment A)

2 Poles

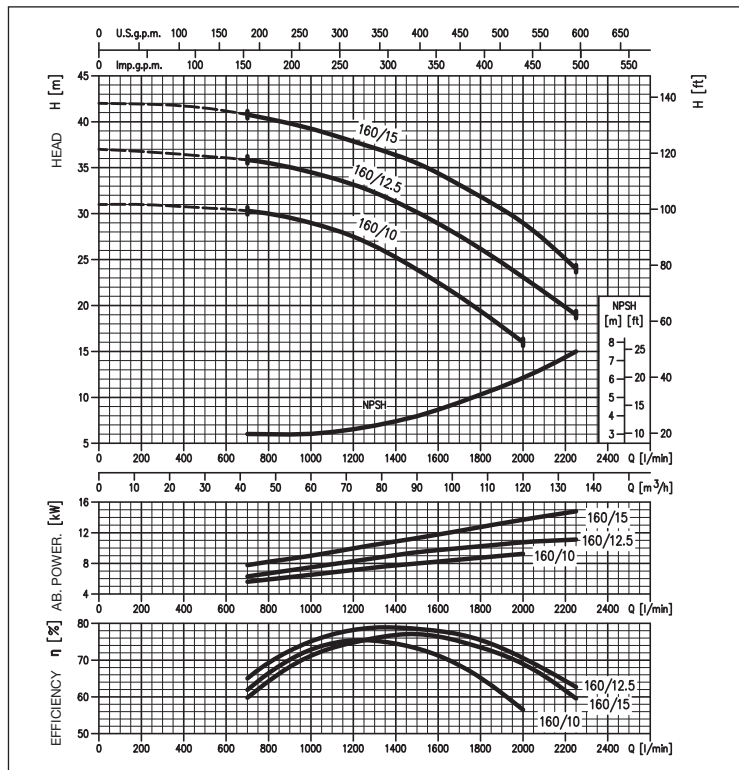

### LPC 80-200 range PERFORMANCE CURVES

(according to ISO 9906 Attachment A)

2 Poles

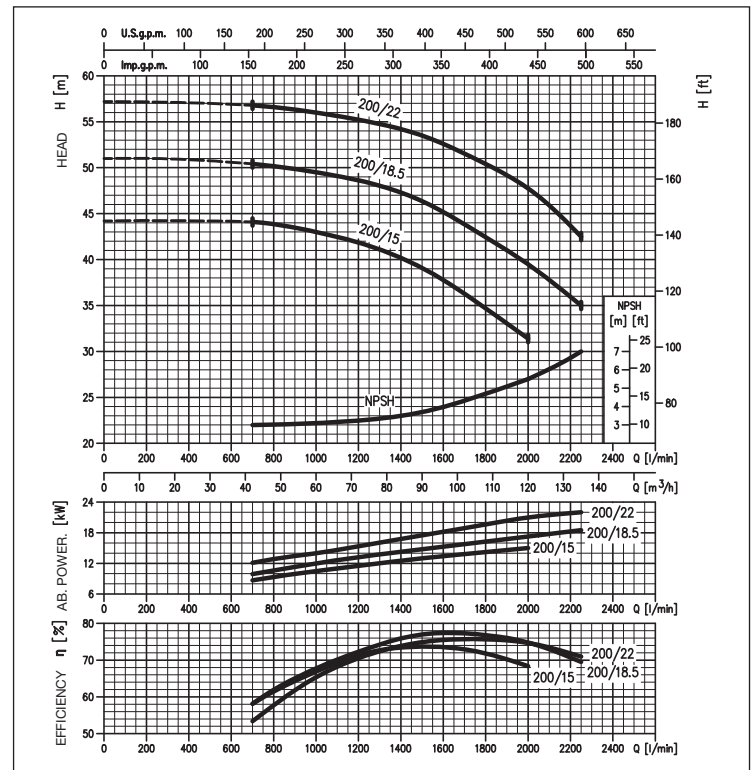



## IN-LINE CENTRIFUGAL ELECTRIC PUMPS

in cast iron

### LPC 100-160 range PERFORMANCE CURVES

(according to ISO 9906 Attachment A)

2 Poles

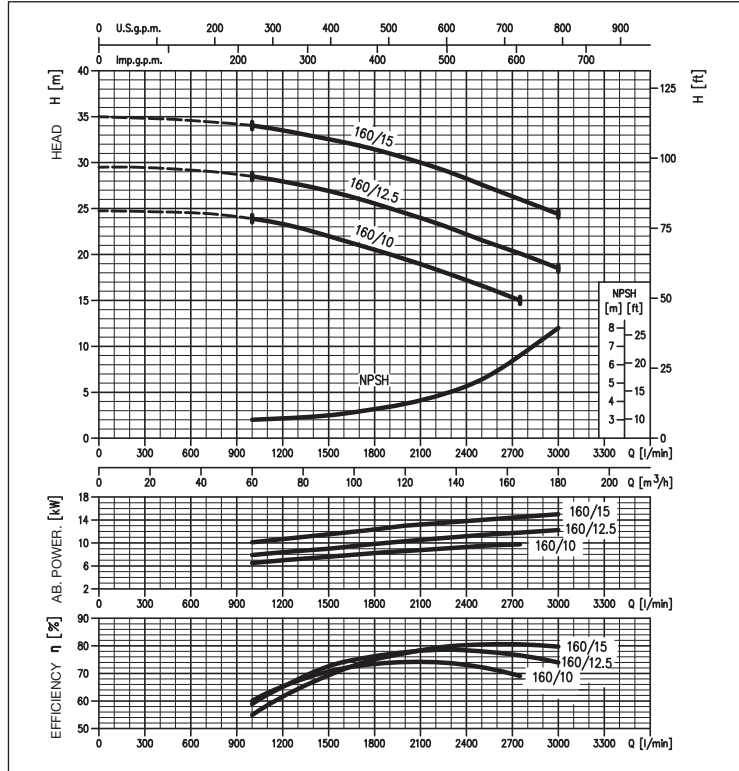

### LPC 100-200 range PERFORMANCE CURVES

(according to ISO 9906 Attachment A)

2 Poles

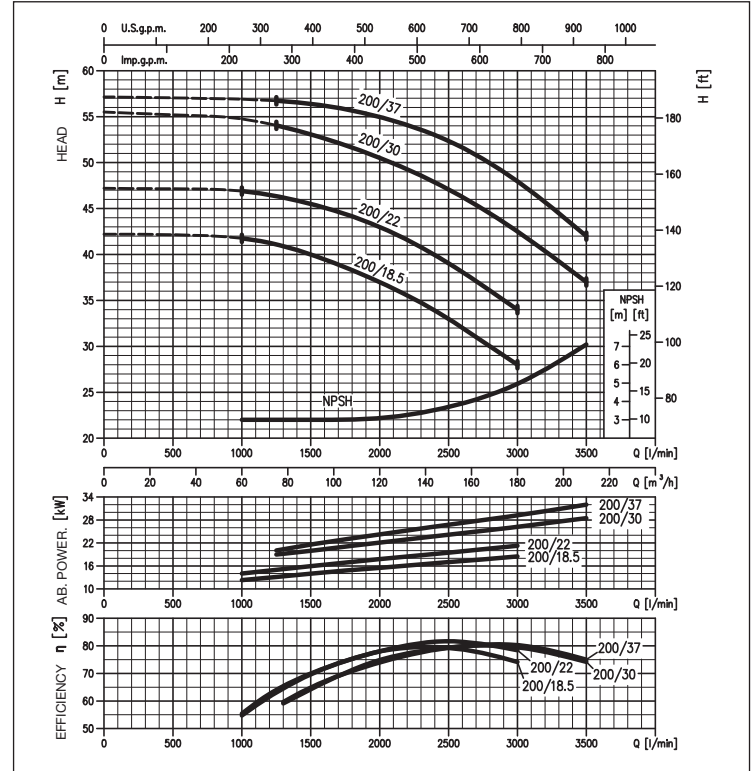

### LPC 100-250 range PERFORMANCE CURVES

(according to ISO 9906 Attachment A)

2 Poles

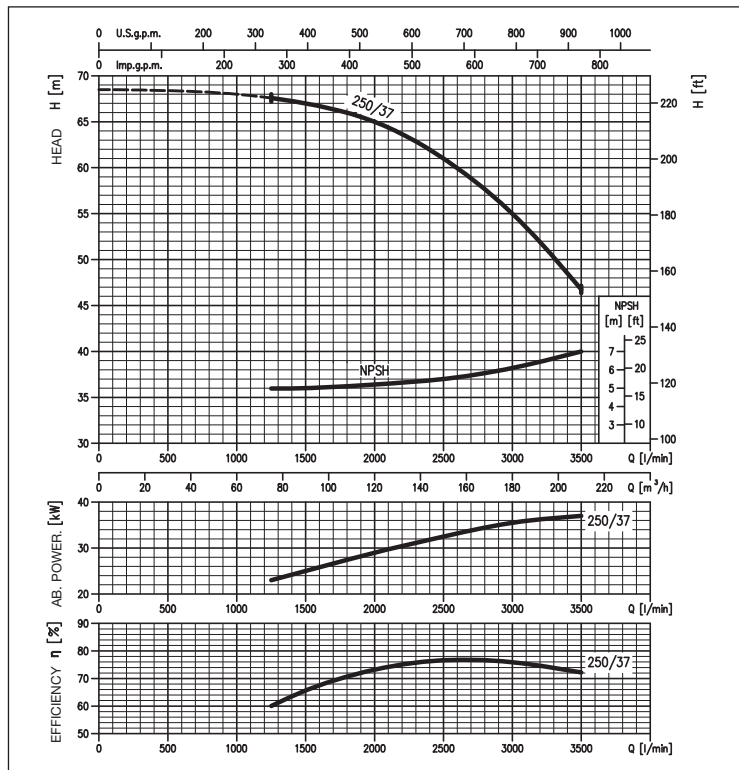

# LPC - LPCD

## IN-LINE CENTRIFUGAL ELECTRIC PUMPS

in cast iron

### LPCD 40-125 range PERFORMANCE CURVES

(according to ISO 9906 Attachment A)

2 Poles

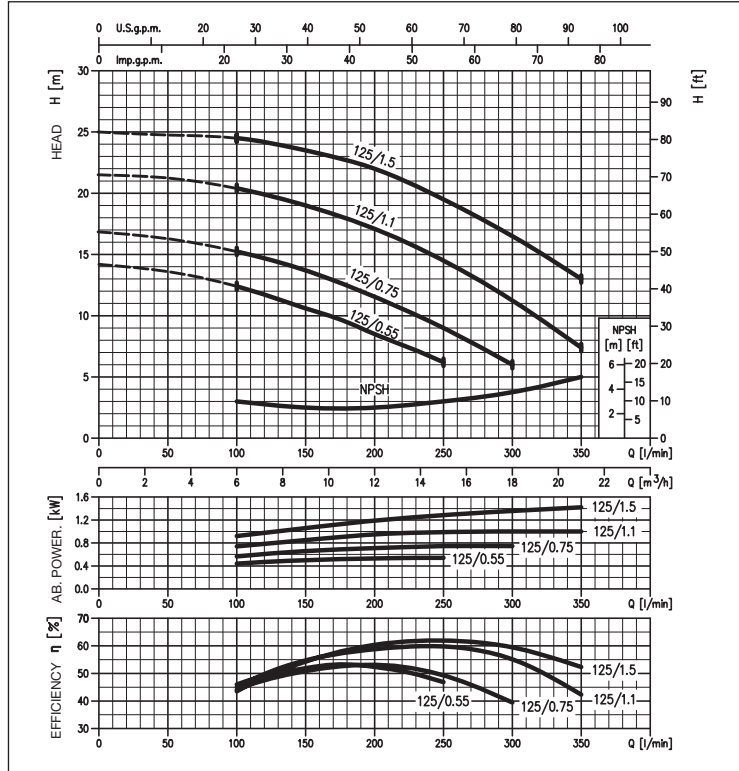

### LPCD 50-125 range PERFORMANCE CURVES

(according to ISO 9906 Attachment A)

2 Poles

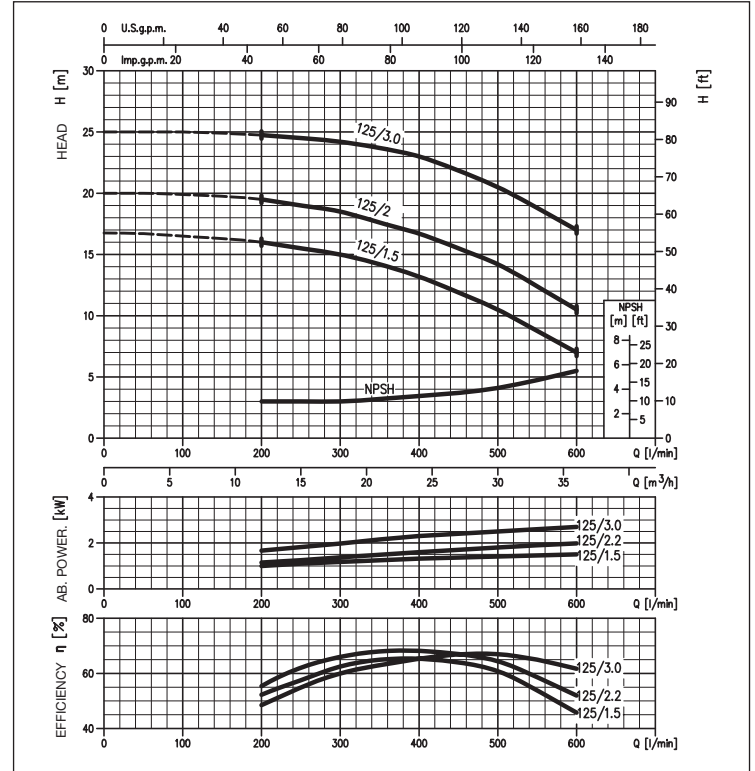

### LPCD 50-160 range PERFORMANCE CURVES

(according to ISO 9906 Attachment A)

2 Poles

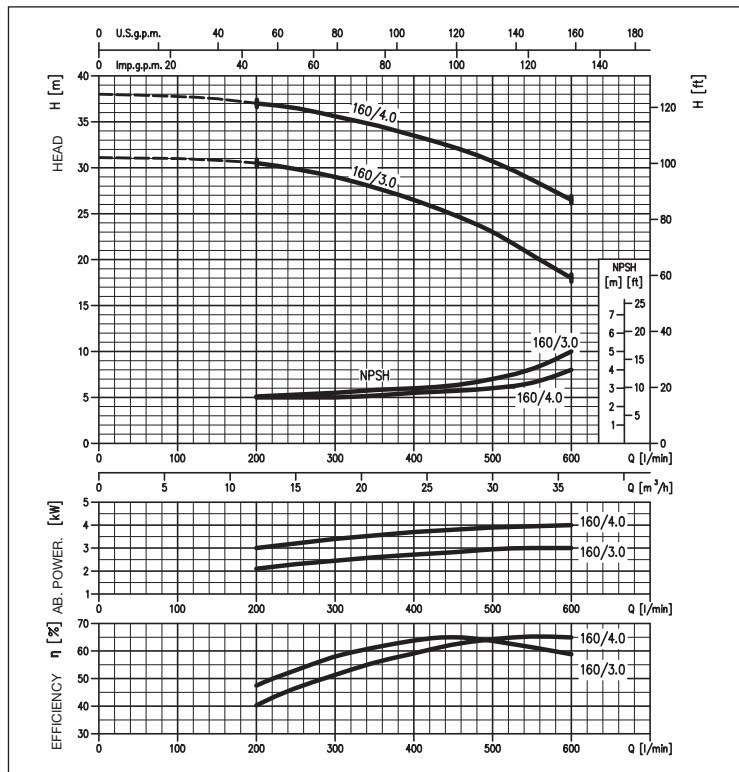

### LPCD 65-160 range PERFORMANCE CURVES

(according to ISO 9906 Attachment A)

2 Poles

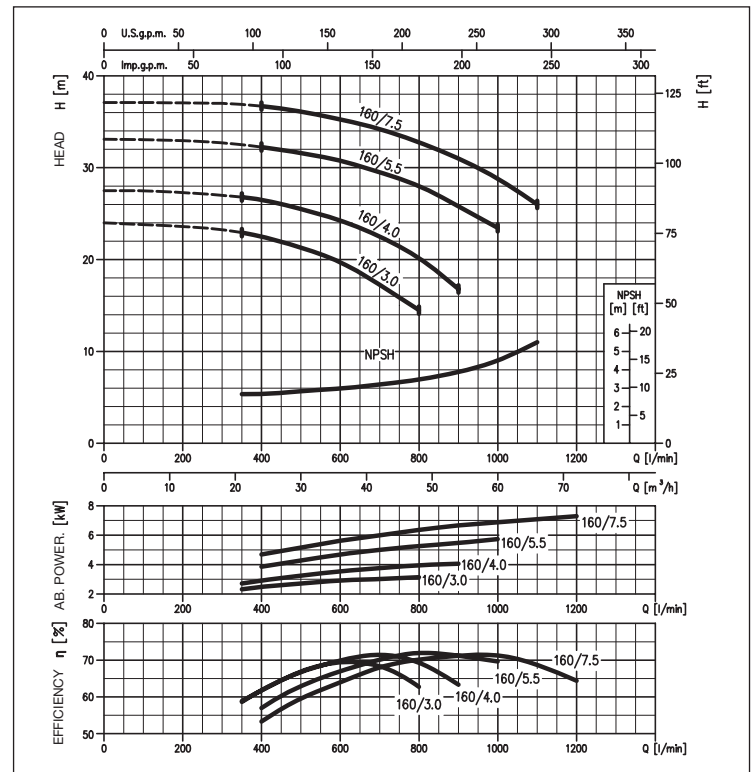

## IN-LINE CENTRIFUGAL ELECTRIC PUMPS

in cast iron

### LPCD 80-160 range PERFORMANCE CURVES

(according to ISO 9906 Attachment A)

2 Poles

### LPCD 100-200 range PERFORMANCE CURVES

(according to ISO 9906 Attachment A)

2 Poles

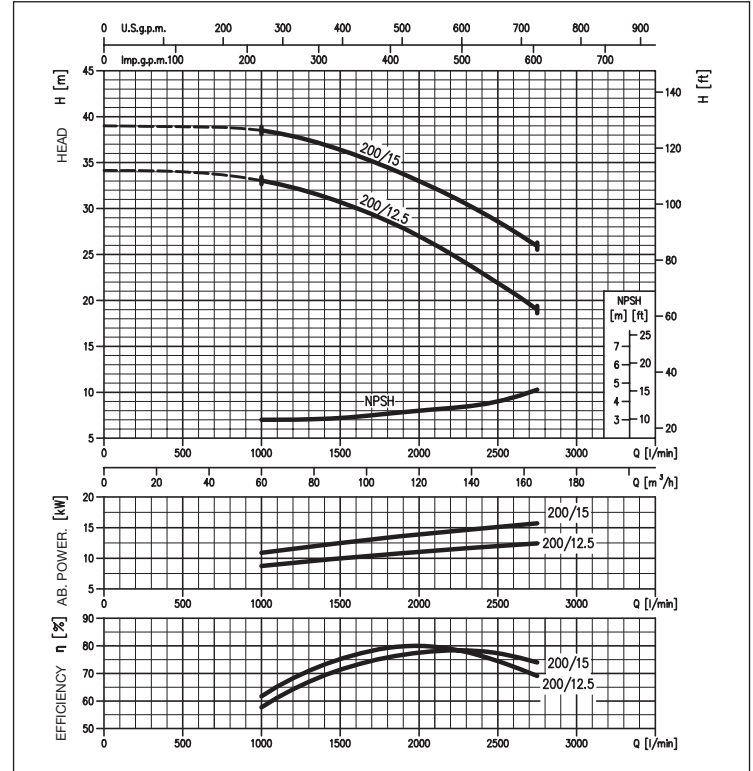
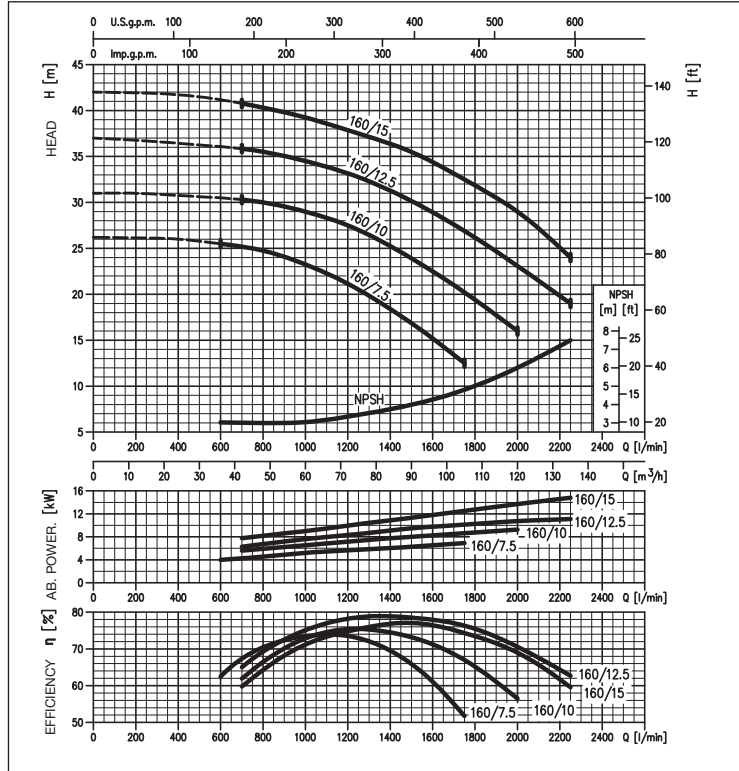

# LPC - LPCD

## IN-LINE CENTRIFUGAL ELECTRIC PUMPS

in cast iron

### LPC4 40-100 range PERFORMANCE CURVES

(according to ISO 9906 Attachment A)

4 Poles

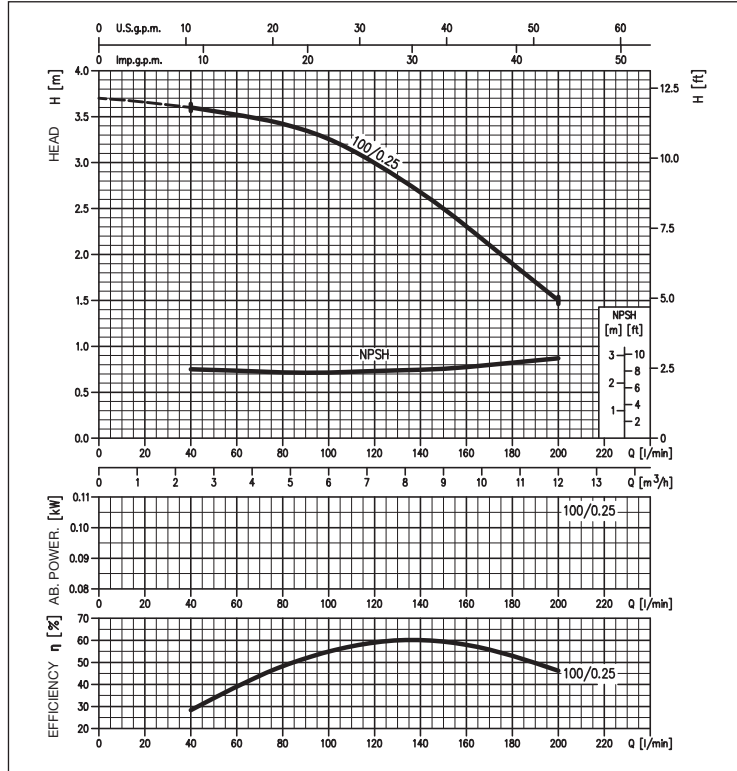

### LPC4 40-125 range PERFORMANCE CURVES

(according to ISO 9906 Attachment A)

4 Poles

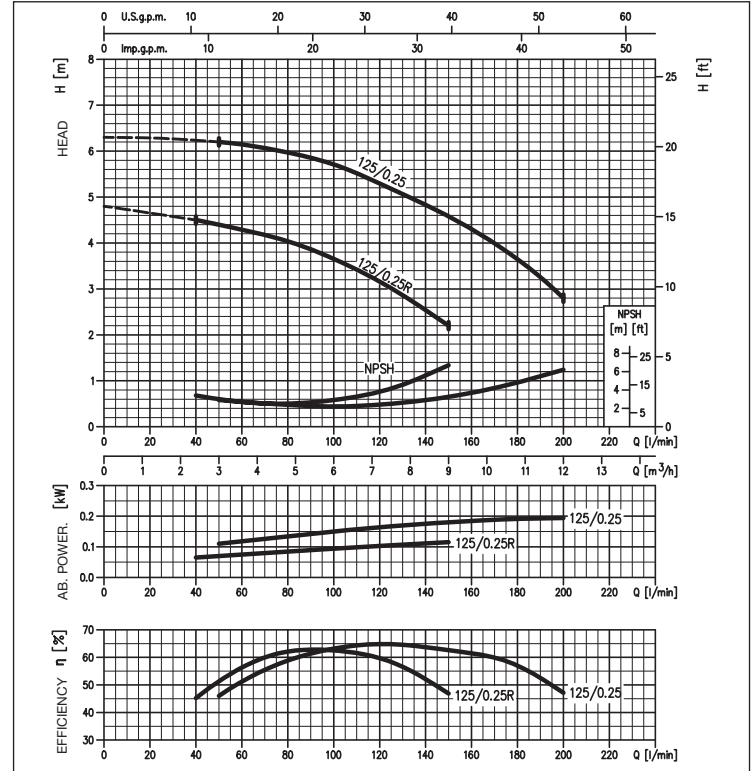

### LPC4 40-160 range PERFORMANCE CURVES

(according to ISO 9906 Attachment A)

4 Poles

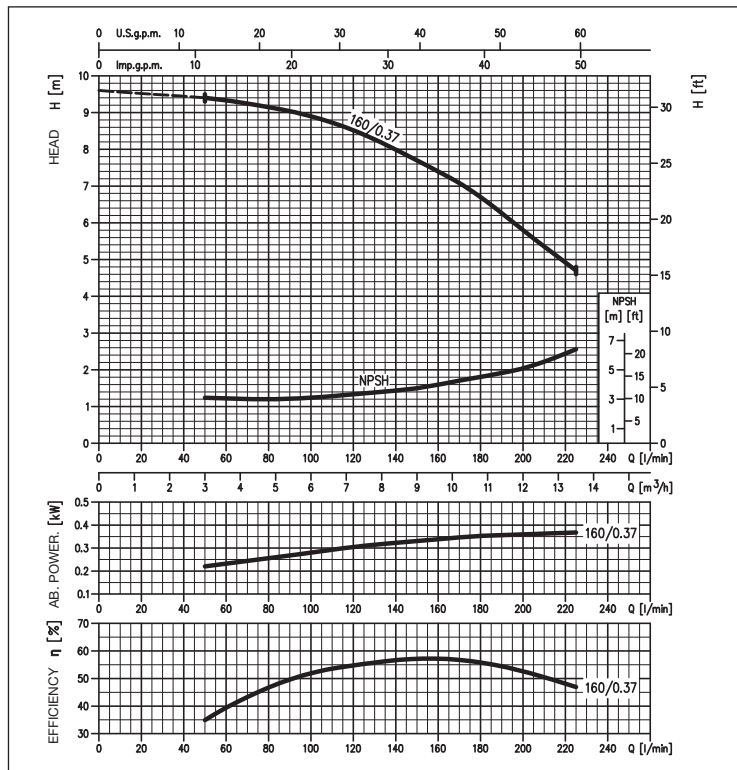

### LPC4 40-200 range PERFORMANCE CURVES

(according to ISO 9906 Attachment A)

4 Poles

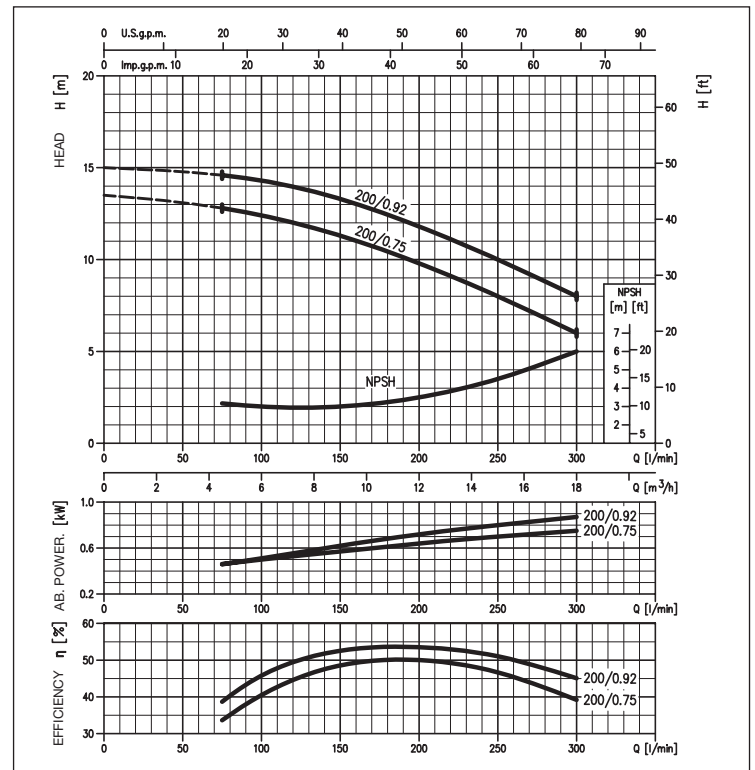

## IN-LINE CENTRIFUGAL ELECTRIC PUMPS

in cast iron

### LPC4 50-125 range PERFORMANCE CURVES

(according to ISO 9906 Attachment A)

4 Poles

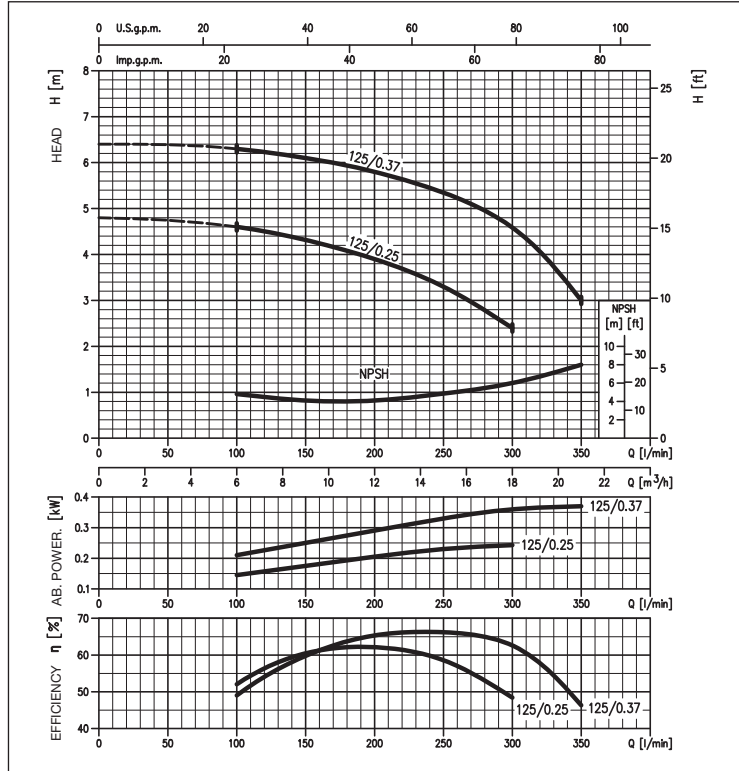

### LPC4 50-160 range PERFORMANCE CURVES

(according to ISO 9906 Attachment A)

4 Poles

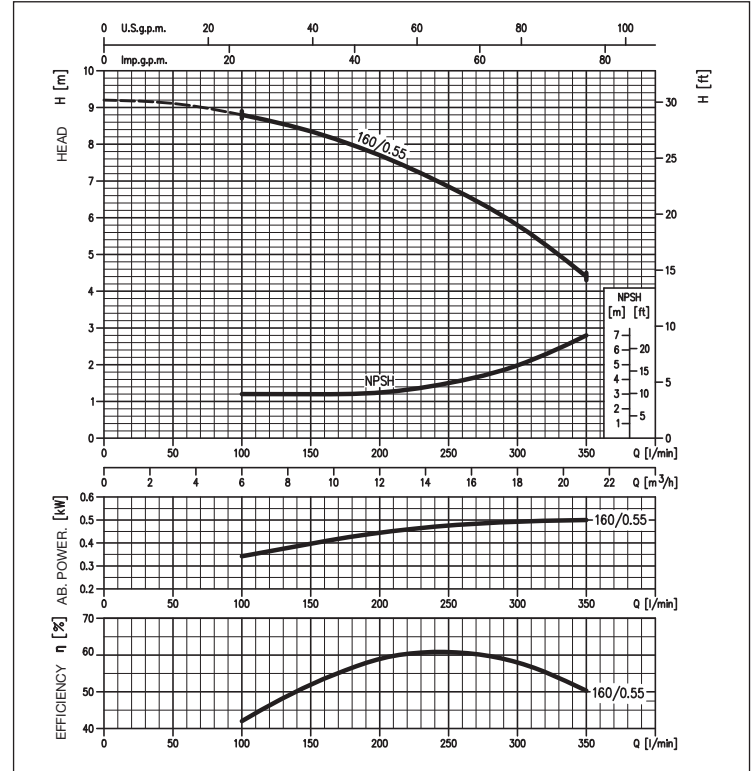

### LPC4 50-200 range PERFORMANCE CURVES

(according to ISO 9906 Attachment A)

4 Poles

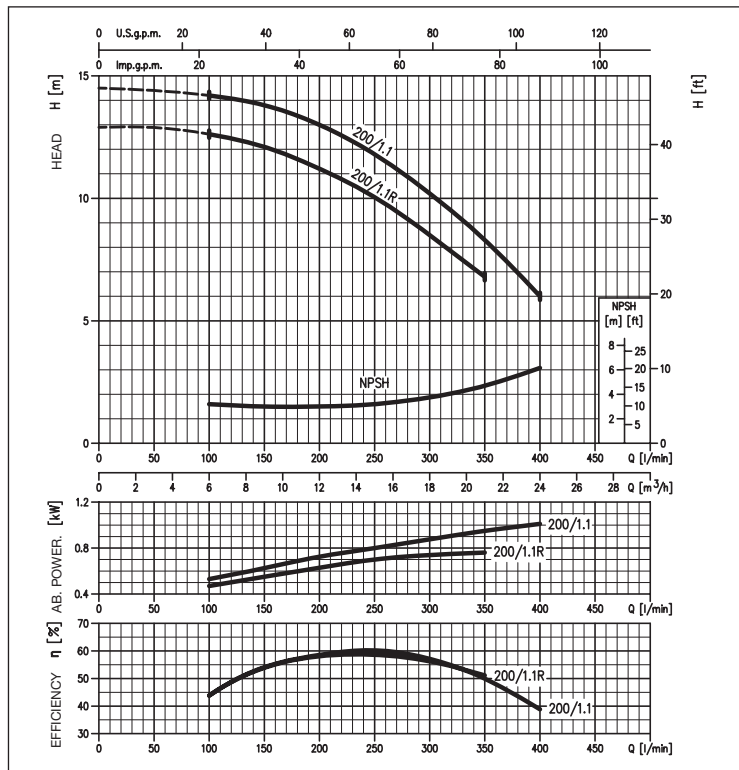

### LPC4 65-125 range PERFORMANCE CURVES

(according to ISO 9906 Attachment A)

4 Poles

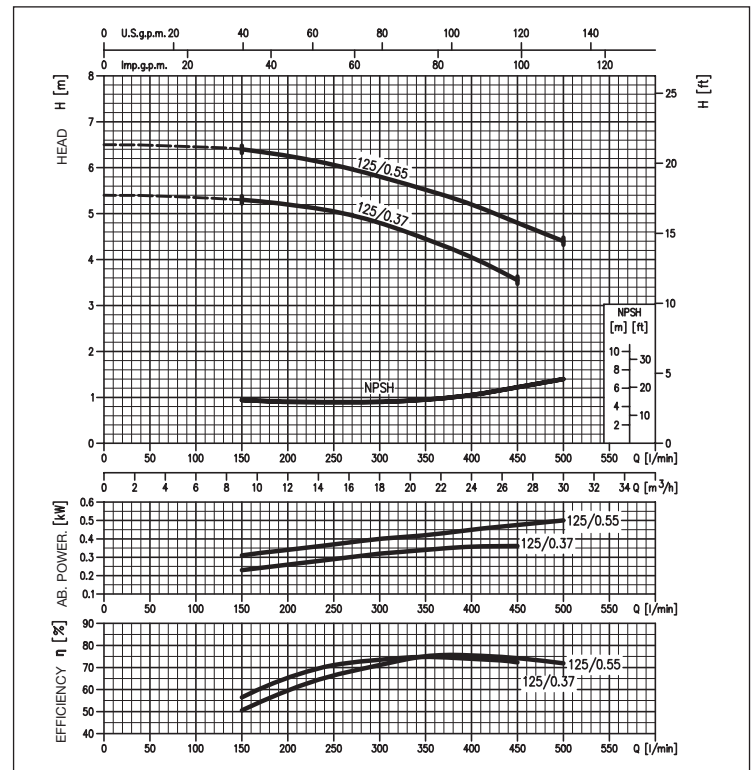

Data under revision. For more information please contact our sales network.

## IN-LINE CENTRIFUGAL ELECTRIC PUMPS

in cast iron

### LPC4 65-160 range PERFORMANCE CURVES

(according to ISO 9906 Attachment A)

4 Poles

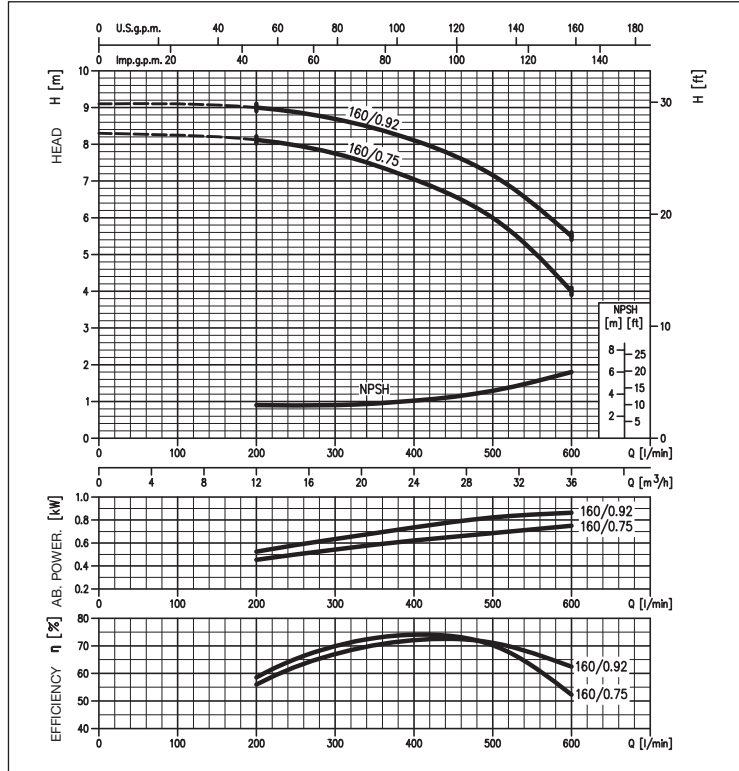

### LPC4 65-200 range PERFORMANCE CURVES

(according to ISO 9906 Attachment A)

4 Poles

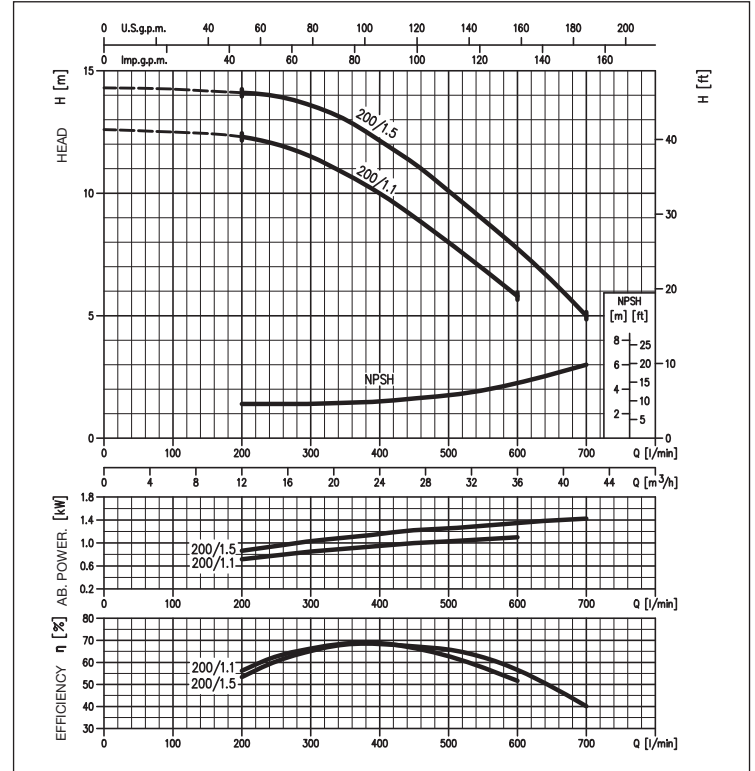

### LPC4 80-160 range PERFORMANCE CURVES

(according to ISO 9906 Attachment A)

4 Poles

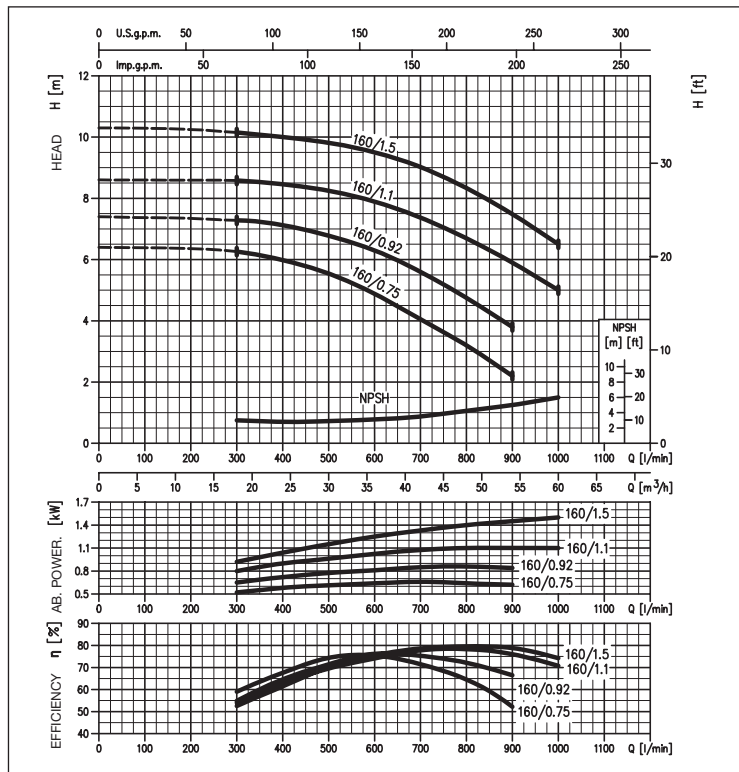

### LPC4 80-200 range PERFORMANCE CURVES

(according to ISO 9906 Attachment A)

4 Poles

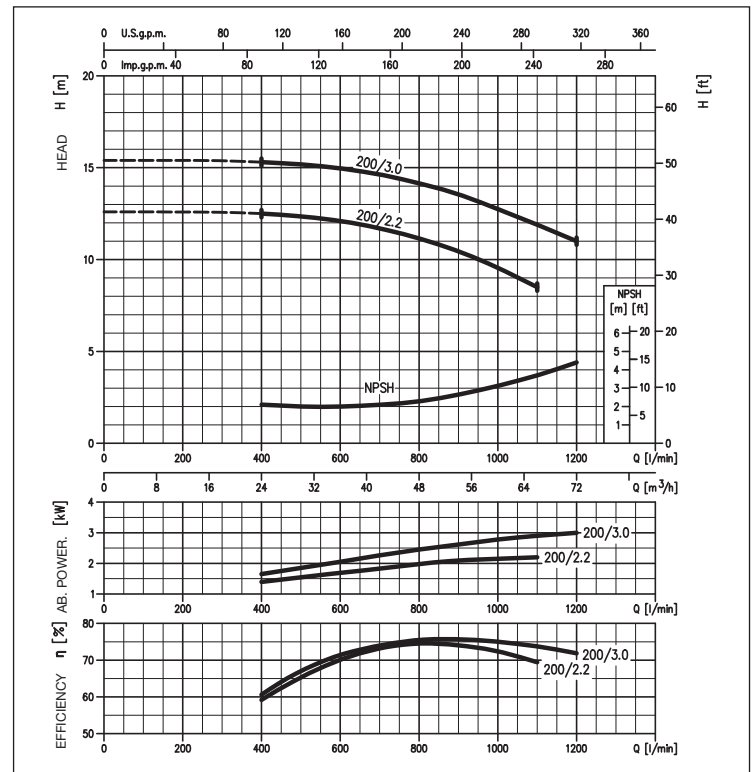

Data under revision. For more information please contact our sales network.



## IN-LINE CENTRIFUGAL ELECTRIC PUMPS

in cast iron

### LPC4 100-160 range PERFORMANCE CURVES

(according to ISO 9906 Attachment A)

4 Poles

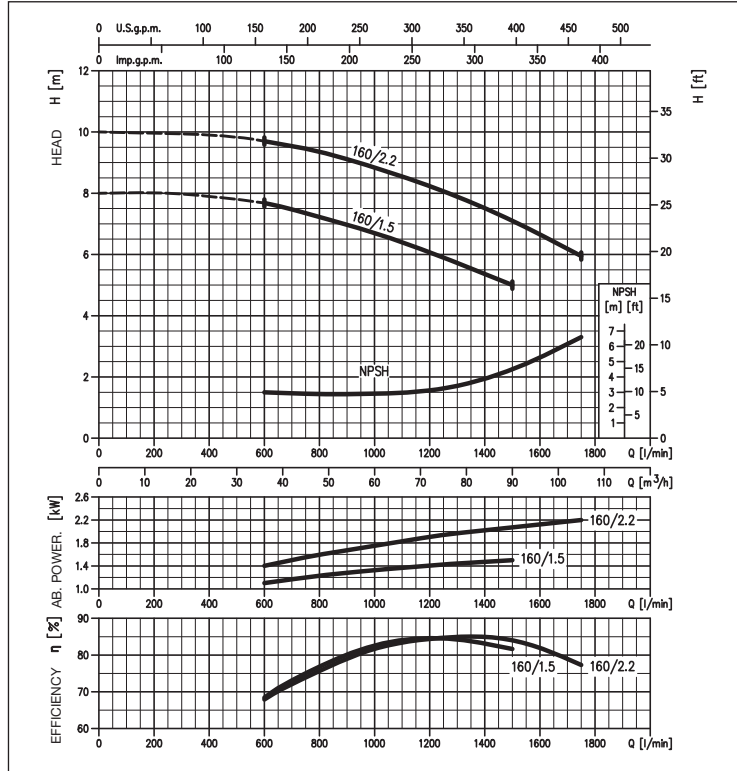

### LPC4 100-200 range PERFORMANCE CURVES

(according to ISO 9906 Attachment A)

4 Poles

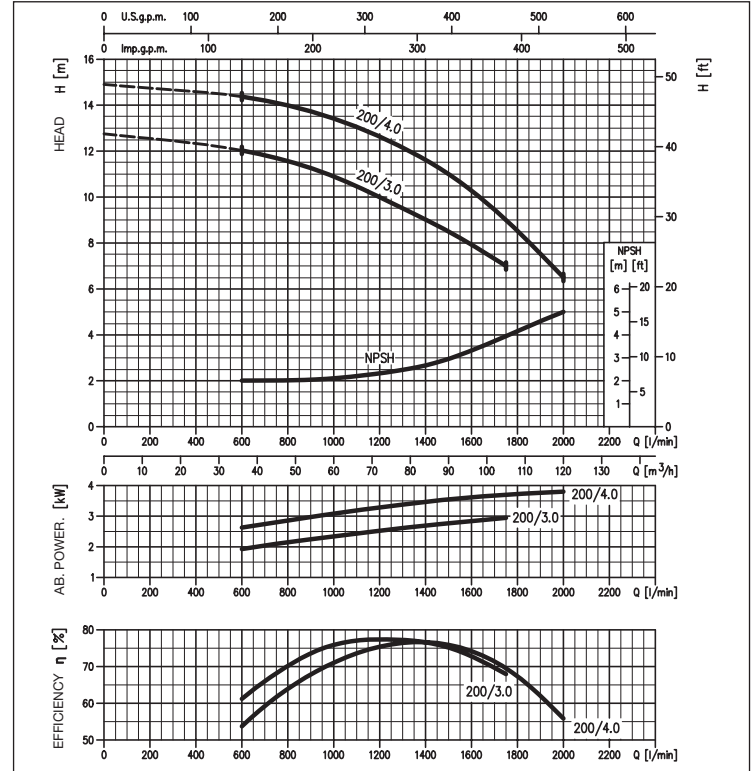

### LPC4 100-250 range PERFORMANCE CURVES

(according to ISO 9906 Attachment A)

4 Poles

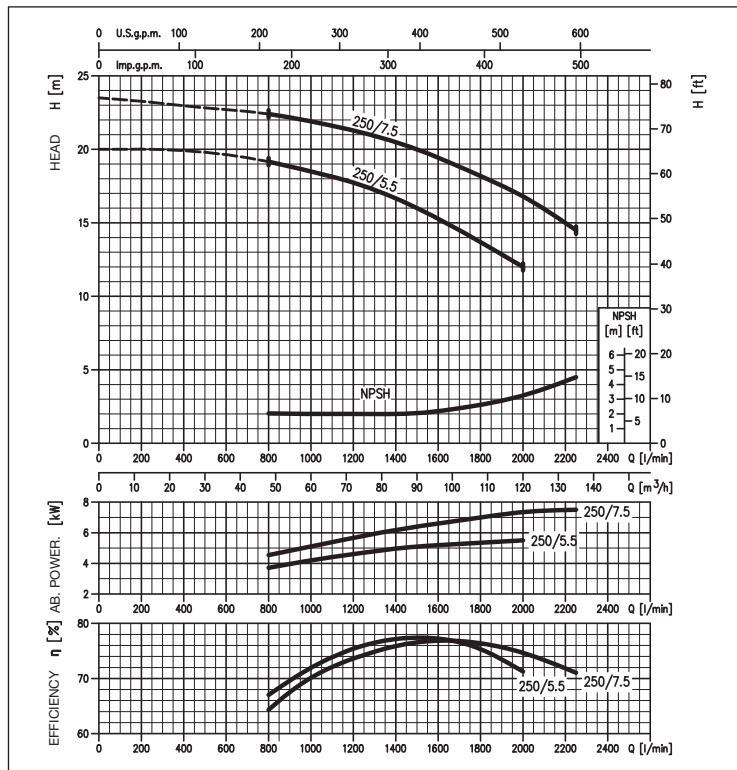

Data under revision. For more information please contact our sales network.

## IN-LINE CENTRIFUGAL ELECTRIC PUMPS

in cast iron

**LPCD4 40-100/40-125 range PERFORMANCE CURVES** 4 Poles  
(according to ISO 9906 Attachment A)

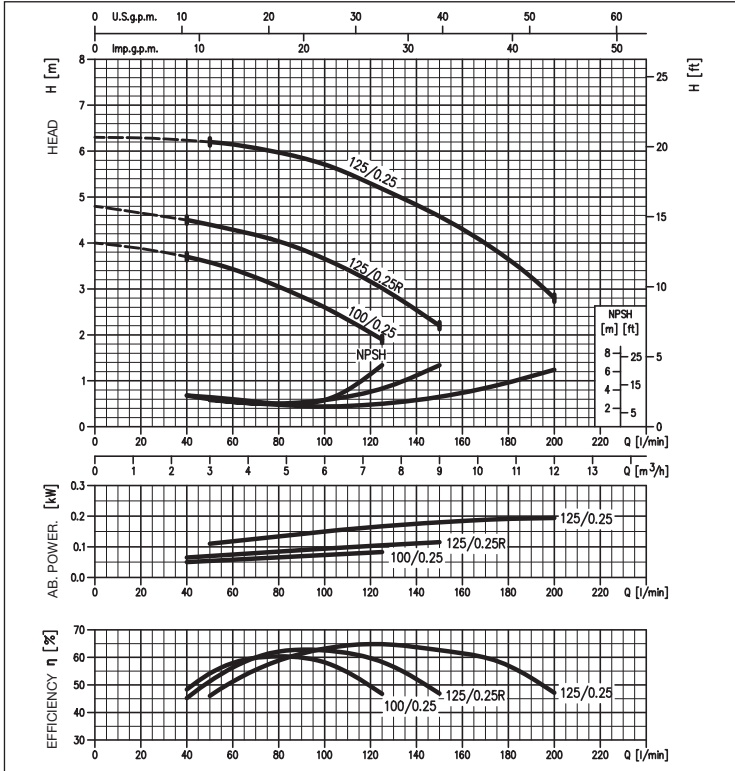

**LPCD4 50-125 range PERFORMANCE CURVES** 4 Poles  
(according to ISO 9906 Attachment A)

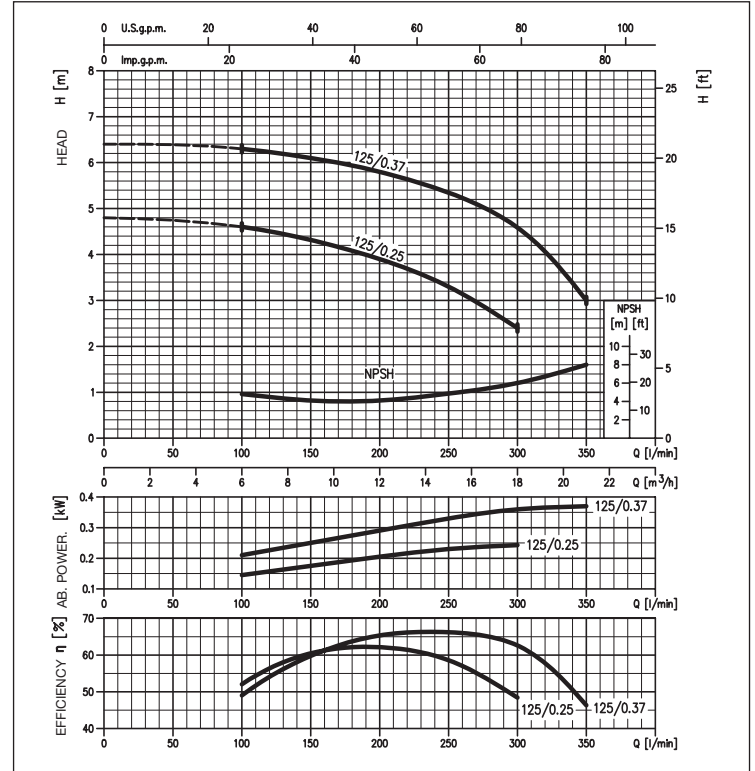

**LPCD4 50-160 range PERFORMANCE CURVES** 4 Poles  
(according to ISO 9906 Attachment A)

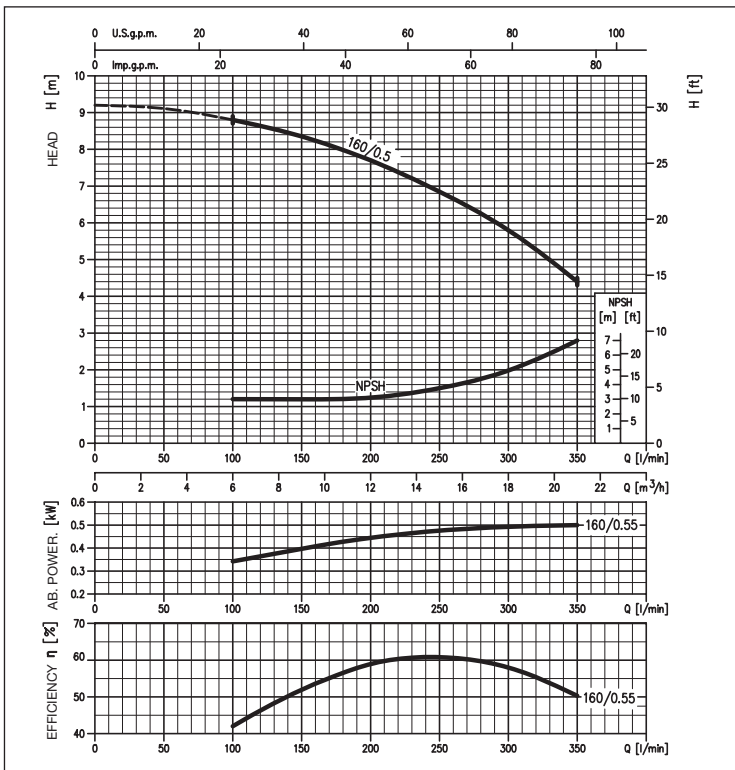

**LPCD4 65-160 range PERFORMANCE CURVES** 4 Poles  
(according to ISO 9906 Attachment A)

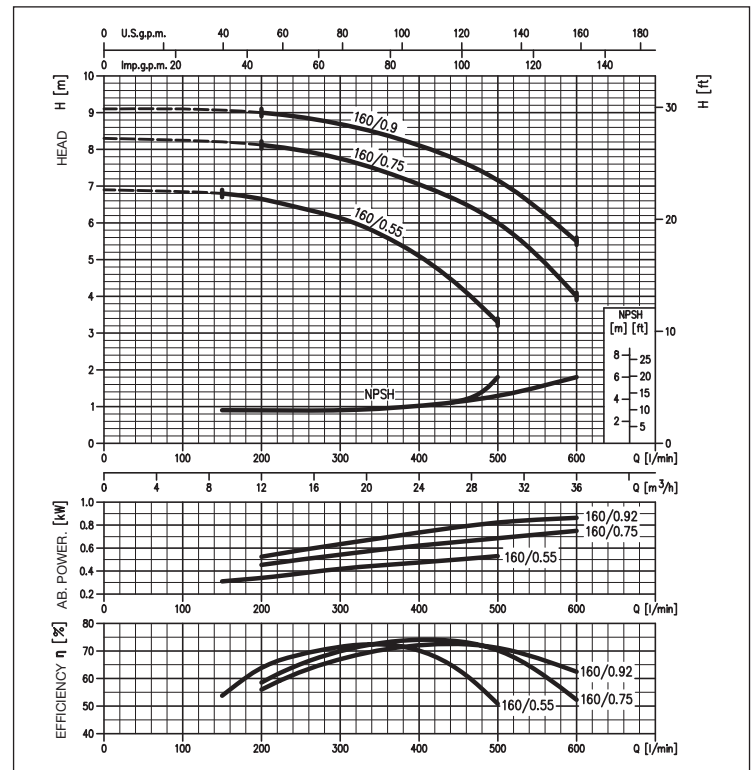

Data under revision. For more information please contact our sales network.

## IN-LINE CENTRIFUGAL ELECTRIC PUMPS

in cast iron

### LPCD4 80-160 range PERFORMANCE CURVES

(according to ISO 9906 Attachment A)

4 Poles

### LPCD4 100-200 range PERFORMANCE CURVES

(according to ISO 9906 Attachment A)

4 Poles

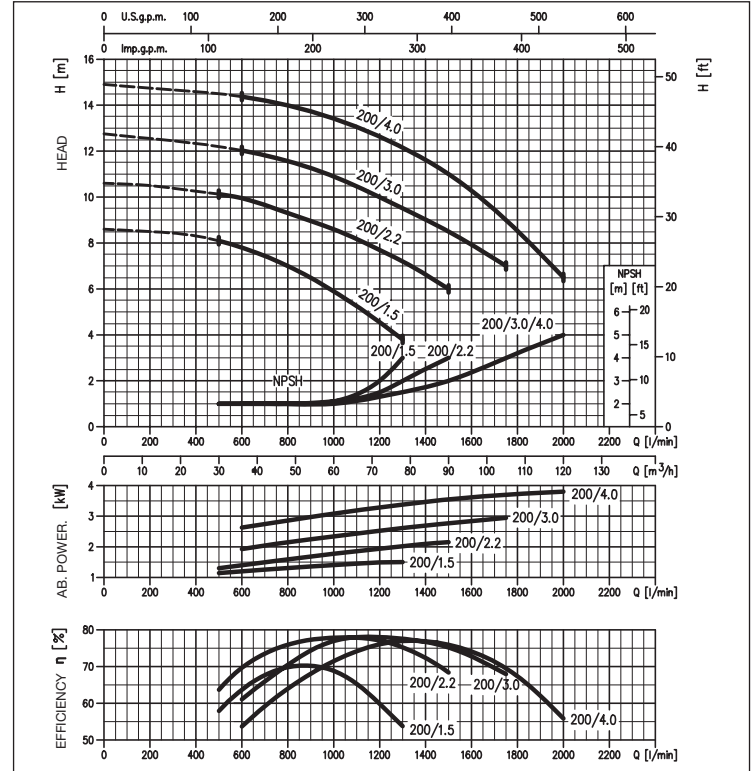
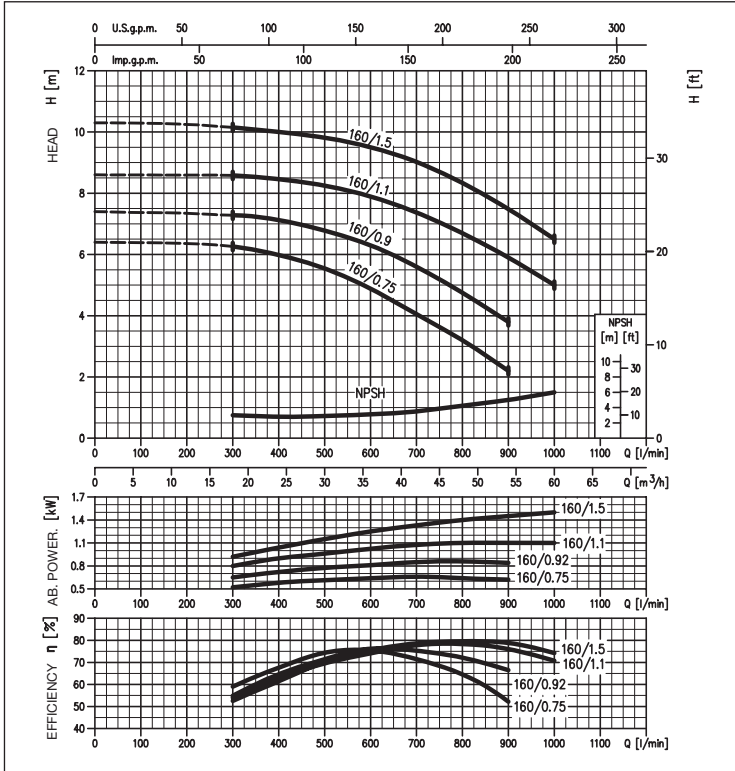

Data under revision. For more information please contact our sales network.

# LPC - LPCD

## IN-LINE CENTRIFUGAL ELECTRIC PUMPS

in cast iron

### LPC 40-50 DIMENSIONS

2 Poles

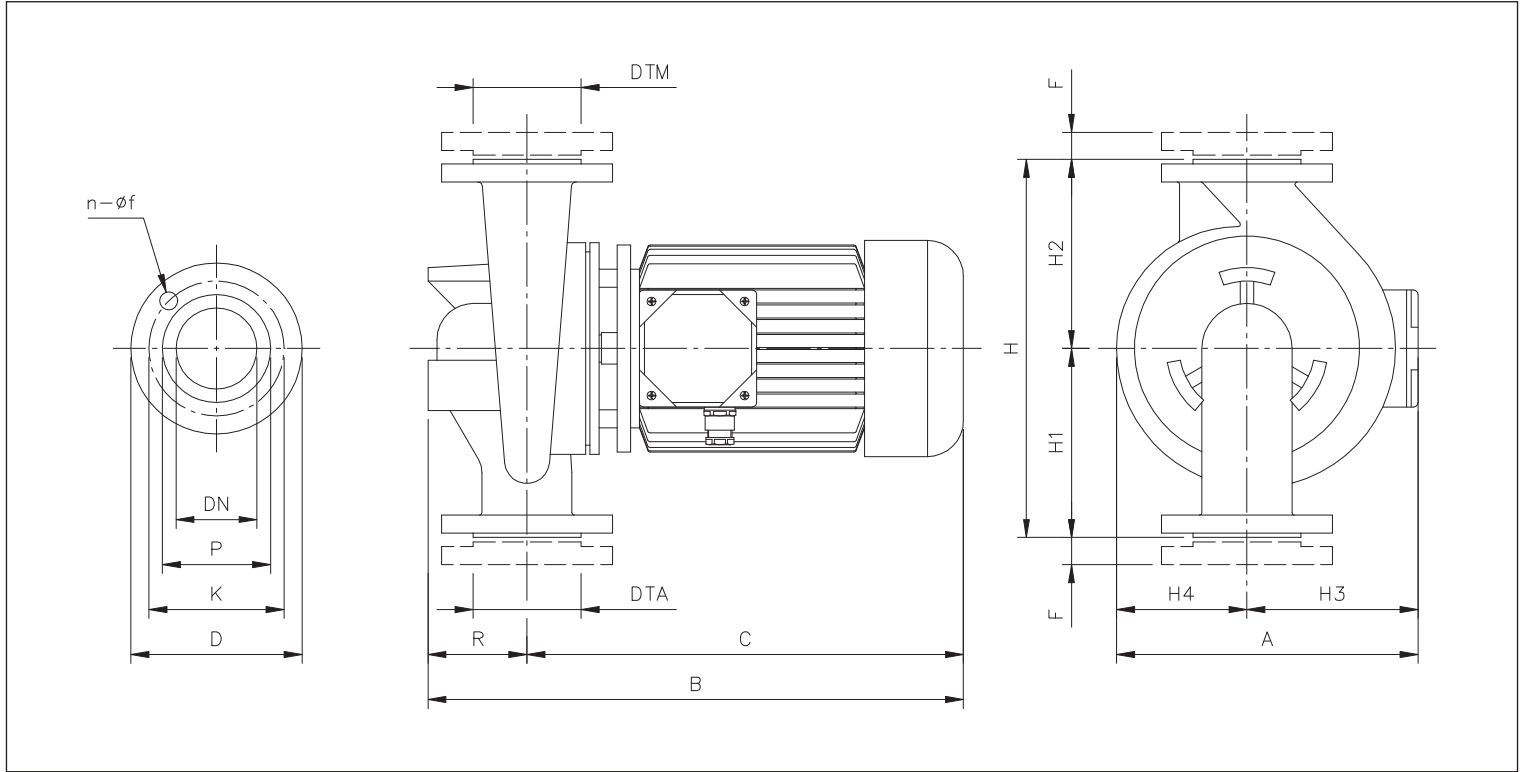

### DIMENSIONS TABLE

Model	Dimensions [mm]																		Weight [kg]
	DTA/M	DNA/M	n	f	P	K	D	H	H1	H2	H3	H4	R	F	A	B	C		
LPC 32-100/0.37	G1¼	32PN6	4	14	70	90	120	220	110	110	107	65	65	16	172	395	330	12,0	
LPC 40-100/0.55	G1½	40PN6	4	14	80	100	130	240	140	120	107	77	90	16	184	445	335	16,0	
LPC 40-100/0.75	G1½	40PN6	4	14	80	100	130	240	140	120	107	77	90	16	184	445	335	16,0	
LPC 40-125/0.75	G1½	40PN10	4	18	88	110	150	300	160	140	107	93	100	20	200	425	325	24,0	
LPC 40-125/1.1	G1½	40PN10	4	18	88	110	150	300	160	140	118	93	100	20	211	445	345	25,0	
LPC 40-125/1.5	G1½	40PN10	4	18	88	110	150	300	160	140	118	93	100	20	211	445	345	26,0	
LPC 40-160/2.2	G1½	40PN10	4	18	88	110	150	320	170	150	118	108	100	20	226	445	345	30,0	
LPC 40-160/3 R	G1½	40PN10	4	18	88	110	150	320	170	150	149	108	100	20	257	485	385	35,0	
LPC 40-160/3	G1½	40PN10	4	18	88	110	150	320	170	150	149	108	100	20	257	485	385	35,0	
LPC 40-200/4	G1½	40PN10	4	18	88	110	150	380	200	180	159	127	100	20	286	525	425	50,0	
LPC 40-200/5.5	G1½	40PN10	4	18	88	110	150	380	200	180	159	127	100	20	286	535	435	55,0	
LPC 40-200/6.3	G1½	40PN10	4	18	88	110	150	380	200	180	159	127	100	20	286	535	435	56,0	
LPC 50-125/1.5	G2	50PN10	4	18	102	125	165	320	180	140	118	103	110	22	221	455	345	27,0	
LPC 50-125/2.2	G2	50PN10	4	18	102	125	165	320	180	140	118	103	110	22	221	455	345	28,0	
LPC 50-125/3	G2	50PN10	4	18	102	125	165	320	180	140	149	103	110	22	252	495	385	32,0	
LPC 50-160/3	G2	50PN10	4	18	102	125	165	340	180	160	149	113	110	22	262	495	385	32,0	
LPC 50-160/4	G2	50PN10	4	18	102	125	165	340	180	160	159	113	110	22	272	535	425	42,0	
LPC 50-200/5.5	G2	50PN10	4	18	102	125	165	400	220	180	159	131	110	22	290	545	435	56,0	
LPC 50-200/6.3	G2	50PN10	4	18	102	125	165	400	220	180	159	131	110	22	290	545	435	57,0	
LPC 50-200/7.5	G2	50PN10	4	18	102	125	165	400	220	180	184	131	110	22	315	650	540	64,0	

Data under revision. For more information please contact our sales network.

## IN-LINE CENTRIFUGAL ELECTRIC PUMPS

in cast iron

### LPC 65-80-100 DIMENSIONS

2 Poles

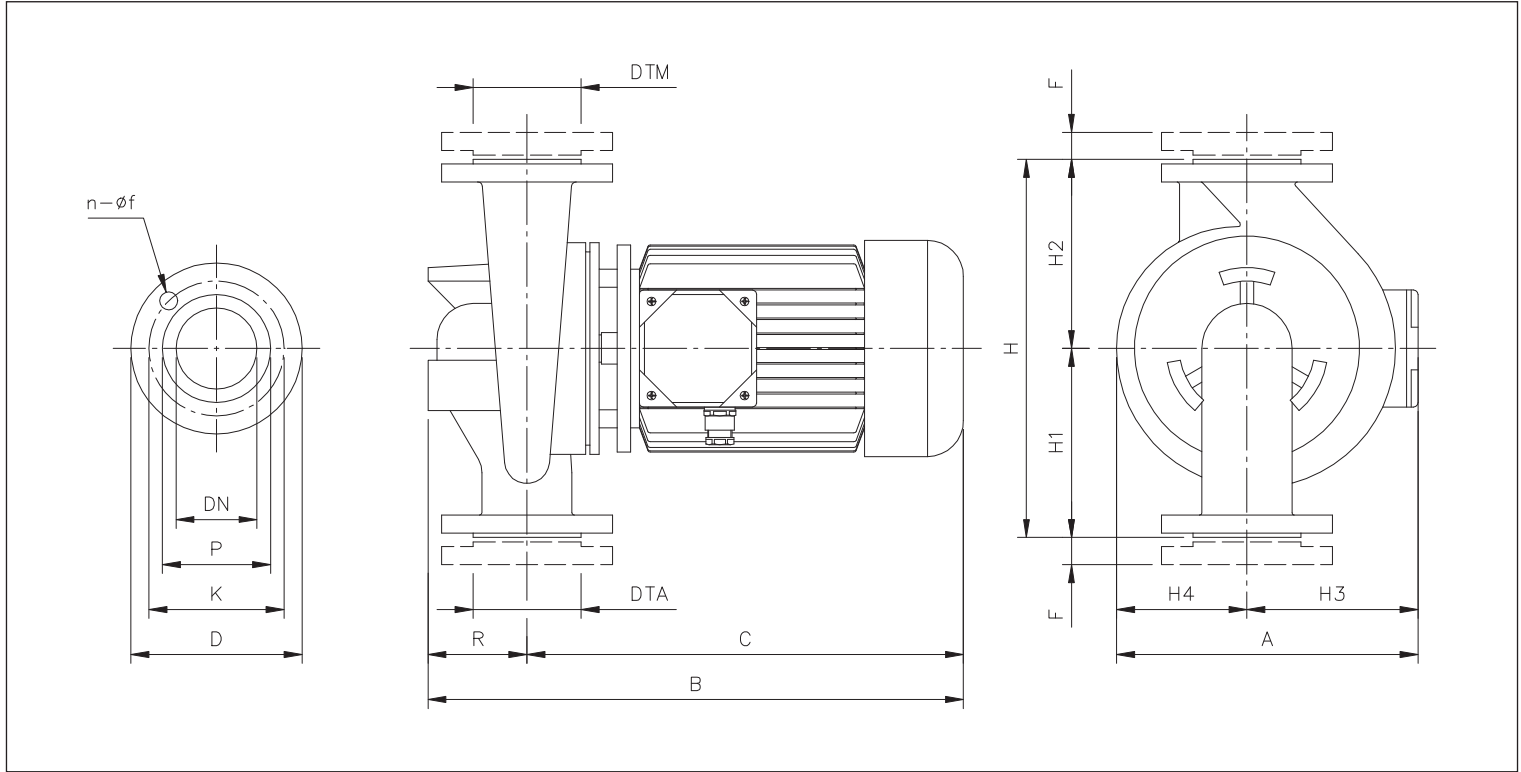

### DIMENSIONS TABLE

Model	Dimensions [mm]																		Weight [kg]
	DTA/M	DNA/M	n	f	P	K	D	H	H1	H2	H3	H4	R	F	A	B	C		
LPC 65-125/2.2	G2½	65PN10	4	18	122	145	185	360	205	155	118	108	140	22	226	485	345	32,0	
LPC 65-125/3.0	G2½	65PN10	4	18	122	145	185	360	205	155	149	108	140	22	257	525	385	39,0	
LPC 65-125/4.0	G2½	65PN10	4	18	122	145	185	360	205	155	159	108	140	22	267	565	425	43,0	
LPC 65-160/5.5	G2½	65PN10	4	18	122	145	185	400	220	180	159	122	140	22	281	575	435	54,0	
LPC 65-160/7.5	G2½	65PN10	4	18	122	145	185	400	220	180	184	122	140	22	306	680	540	61,0	
LPC 65-200/10	G2½	65PN10	4	18	122	145	185	440	240	200	184	136	140	22	320	680	540	70,0	
LPC 65-200/12.5	G2½	65PN10	4	18	122	145	185	440	240	200	184	136	140	22	320	680	540	77,0	
LPC 80-160/10	G3	80PN10	8	18	138	160	200	440	240	200	184	131	160	24	315	700	540	72,0	
LPC 80-160/12.5	G3	80PN10	8	18	138	160	200	440	240	200	184	131	160	24	315	700	540	79,0	
LPC 80-160/15	G3	80PN10	8	18	138	160	200	440	240	200	184	131	160	24	315	700	540	85,0	
LPC 80-200/15	G3	80PN10	8	18	138	160	200	500	275	225	184	146	160	24	330	700	540	91,0	
LPC 80-200/18.5	G3	80PN10	8	18	138	160	200	500	275	225	229	146	160	24	375	860	700	124,0	
LPC 80-200/22	G3	80PN10	8	18	138	160	200	500	275	225	229	146	160	24	375	860	700	142,0	
LPC 100-160/10	G4	100PN10	8	18	158	180	220	525	300	225	184	136	190	26	320	730	540	76,0	
LPC 100-160/12.5	G4	100PN10	8	18	158	180	220	525	300	225	184	136	190	26	320	730	540	84,0	
LPC 100-160/15	G4	100PN10	8	18	158	180	220	525	300	225	184	136	190	26	320	730	540	91,0	
LPC 100-200/18.5	G4	100PN10	8	18	158	180	220	550	300	250	230	156	190	26	386	890	710	135,0	
LPC 100-200/22	G4	100PN10	8	18	158	180	220	550	300	250	230	156	190	26	386	890	710	153,0	
LPC 100-200/30	G4	100PN10	8	18	158	180	220	550	300	250	257	156	190	26	413	995	805	195,0	
LPC 100-200/37	G4	100PN10	8	18	158	180	220	550	300	250	257	156	190	26	413	995	805	213,0	
LPC 100-250/37	G4	100PN10	8	18	158	180	220	600	320	280	257	176	190	26	433	995	805	220,0	

Data under revision. For more information please contact our sales network.

# LPC - LPCD

## IN-LINE CENTRIFUGAL ELECTRIC PUMPS

in cast iron

### LPCD 40-50-65-80-100 DIMENSIONS

2 Poles

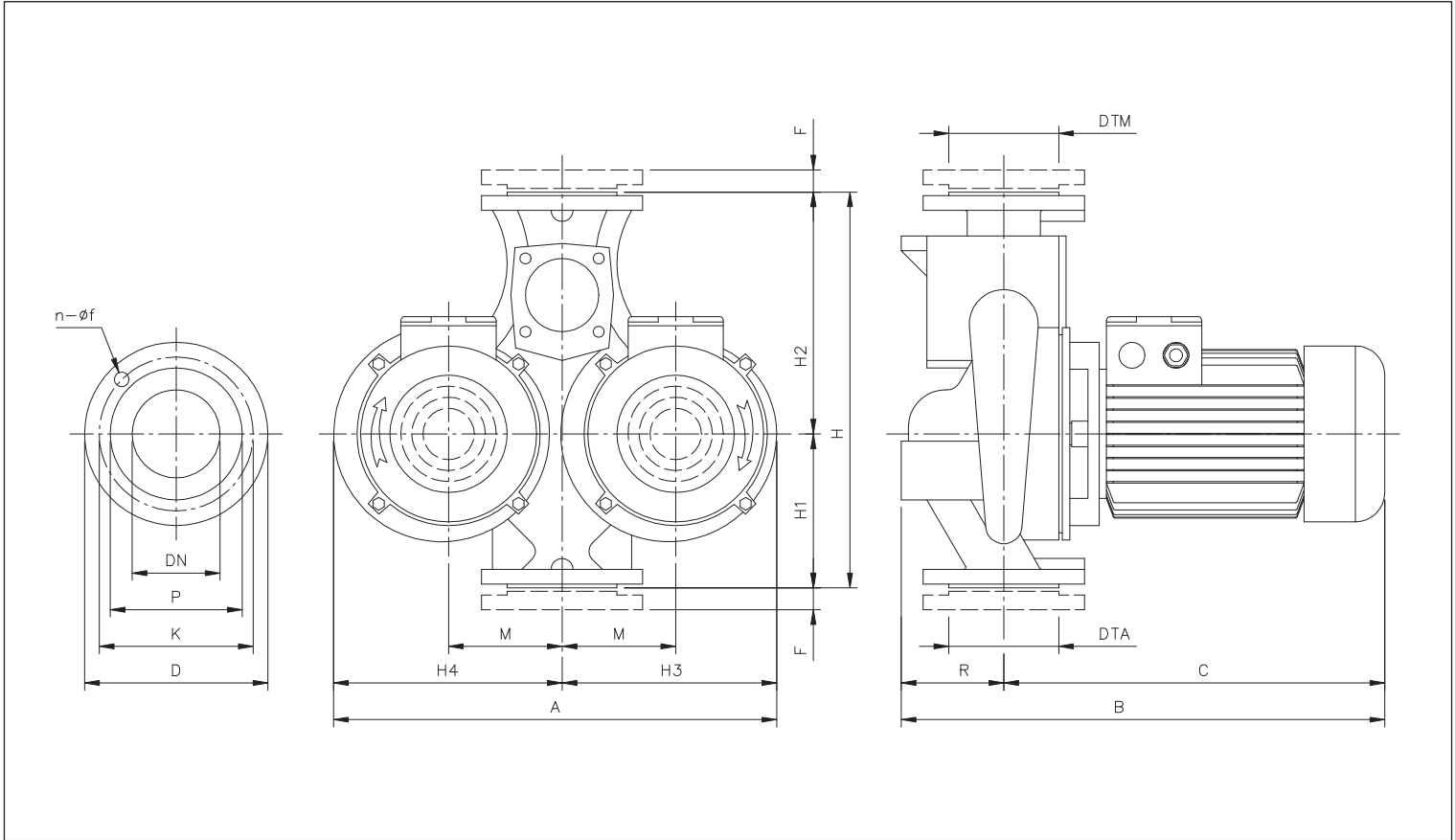

### DIMENSIONS TABLE

Model	Dimensions [mm]																Weight [kg]		
	DTA/M	DNA/M	n	f	P	K	D	H	H1	H2	H3	H4	M	R	F	A		B	C
LPCD 40-125/0.55	G1½	40PN10	4	18	88	110	150	340	130	210	197	200	100	100	20	397	425	325	50,0
LPCD 40-125/0.75	G1½	40PN10	4	18	88	110	150	340	130	210	197	200	100	100	20	397	425	325	50,0
LPCD 40-125/1.1	G1½	40PN10	4	18	88	110	150	340	130	210	197	200	100	100	20	397	445	345	52,0
LPCD 40-125/1.5	G1½	40PN10	4	18	88	110	150	340	130	210	197	200	100	100	20	397	445	345	54,0
LPCD 50-125/1.5	G2	50PN10	4	18	102	125	165	365	145	220	210	217	105	110	22	427	455	345	56,0
LPCD 50-125/2.2	G2	50PN10	4	18	102	125	165	365	145	220	210	217	105	110	22	427	455	345	58,0
LPCD 50-125/3.0	G2	50PN10	4	18	102	125	165	365	145	220	210	217	105	110	22	427	495	385	66,0
LPCD 50-160/3.0	G2	50PN10	4	18	102	125	165	410	170	240	235	245	120	110	22	480	495	385	72,0
LPCD 50-160/4.0	G2	50PN10	4	18	102	125	165	410	170	240	235	245	120	110	22	480	535	425	86,0
LPCD 65-160/3.0	G2½	65PN10	4	18	122	145	185	450	180	270	268	275	140	130	22	543	515	385	81,0
LPCD 65-160/4.0	G2½	65PN10	4	18	122	145	185	450	180	270	268	275	140	130	22	543	555	425	101,0
LPCD 65-160/5.5	G2½	65PN10	4	18	122	145	185	450	180	270	268	275	140	130	22	543	565	435	125,0
LPCD 65-160/7.5	G2½	65PN10	4	18	122	145	185	450	180	270	268	275	140	130	22	543	565	435	132,0
LPCD 80-160/7.5	G3	80PN10	8	18	138	160	200	510	205	305	270	280	135	130	24	550	565	435	137,0
LPCD 80-160/10	G3	80PN10	8	18	138	160	200	510	205	305	270	280	135	150	24	550	690	540	141,0
LPCD 80-160/12.5	G3	80PN10	8	18	138	160	200	510	205	305	270	280	135	150	24	550	690	540	162,0
LPCD 80-160/15	G3	80PN10	8	18	138	160	200	510	205	305	270	280	135	150	24	550	690	540	175,0
LPCD 100-200/10	G4	100PN10	8	18	158	180	220	630	240	390	345	325	165	180	26	670	720	540	200,0
LPCD 100-200/12.5 R	G4	100PN10	8	18	158	180	220	630	240	390	345	325	165	180	26	670	720	540	230,0
LPCD 100-200/12.5	G4	100PN10	8	18	158	180	220	630	240	390	345	325	165	180	26	670	720	540	162,0
LPCD 100-200/15 R	G4	100PN10	8	18	158	180	220	630	240	390	345	325	165	180	26	670	720	540	214,0
LPCD 100-200/15	G4	100PN10	8	18	158	180	220	630	240	390	345	325	165	180	26	670	720	540	162,0

Data under revision. For more information please contact our sales network.



# LPC - LPCD

## IN-LINE CENTRIFUGAL ELECTRIC PUMPS

in cast iron

4 Poles

### LPC4 40-50-65-80-100 DIMENSIONS

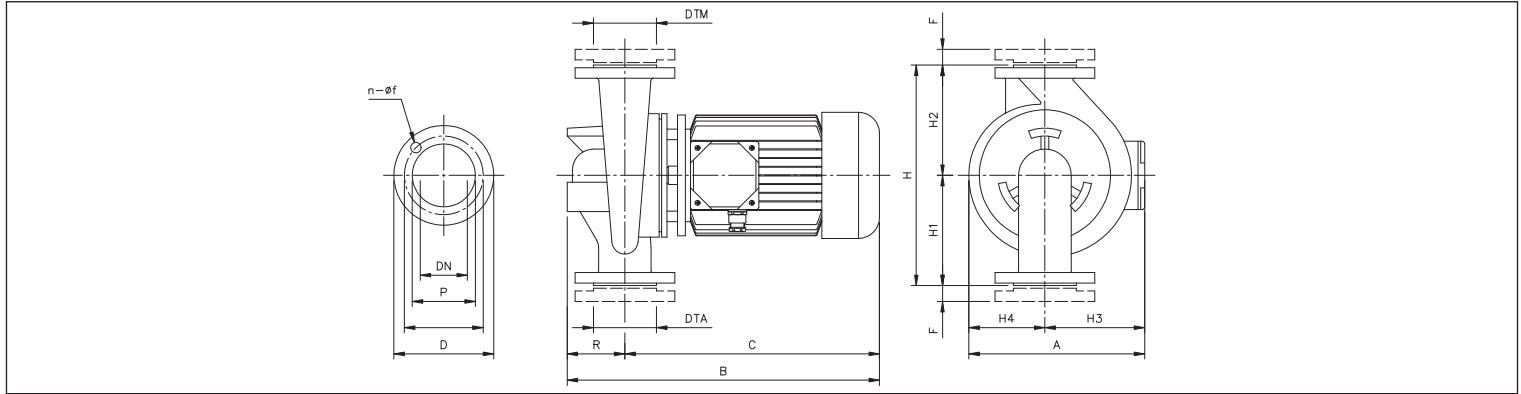

### DIMENSIONS TABLE

Model	Dimensions [mm]																		Weight [kg]
	DTA/M	DNA/M	n	f	P	K	D	H	H1	H2	H3	H4	R	F	A	B	C		
LPC4 32-100/0.25	G1½	32PN6	4	14	70	90	120	220	110	110	107	65	65	16	172	395	330	12,0	
LPC4 40-100/0.25	G1½	40PN6	4	14	80	100	130	260	140	120	107	77	90	16	184	445	355	16,0	
LPC4 40-125/0.25 R	G1½	40PN10	4	18	88	110	150	300	160	140	107	93	100	20	200	425	325	20,0	
LPC4 40-125/0.25	G1½	40PN10	4	18	88	110	150	300	160	140	107	93	100	20	200	425	325	20,0	
LPC4 40-160/0.37	G1½	40PN10	4	18	88	110	150	320	170	150	107	108	100	20	215	425	325	23,0	
LPC4 40-200/0.75	G1½	40PN10	4	18	88	110	150	380	200	180	118	127	100	20	245	445	345	30,0	
LPC4 40-200/0.92	G1½	40PN10	4	18	88	110	150	380	200	180	118	127	100	20	245	445	345	31,0	
LPC4 40-250/1.1	G1½	40PN10	4	18	88	110	150	440	230	210	165	165	100	20	330	485	385	51,0	
LPC4 40-250/1.5	G1½	40PN10	4	18	88	110	150	440	230	210	165	165	100	20	330	485	385	51,0	
LPC4 50-125/0.25	G2	50PN10	4	18	102	125	165	320	180	140	107	103	110	22	210	435	325	21,0	
LPC4 50-125/0.37	G2	50PN10	4	18	102	125	165	320	180	140	107	103	110	22	210	435	325	22,0	
LPC4 50-160/0.55	G2	50PN10	4	18	102	125	165	340	180	160	107	113	110	22	220	435	325	25,0	
LPC4 50-200/1.1 R	G2	50PN10	4	18	102	125	165	400	220	180	149	131	110	22	280	495	385	36,0	
LPC4 50-200/1.1	G2	50PN10	4	18	102	125	165	400	220	180	149	131	110	22	280	495	385	36,0	
LPC4 50-250/1.5	G2	50PN10	4	18	102	125	165	440	230	210	165	165	125	22	330	510	385	52,0	
LPC4 50-250/2.2	G2	50PN10	4	18	102	125	165	440	230	210	165	165	125	22	330	550	425	56,0	
LPC4 65-125/0.37	G2½	65PN10	4	18	122	145	185	360	205	155	107	108	140	22	215	465	325	25,0	
LPC4 65-125/0.55	G2½	65PN10	4	18	122	145	185	360	205	155	107	108	140	22	215	465	325	26,0	
LPC4 65-160/0.75	G2½	65PN10	4	18	122	145	185	400	220	180	118	122	140	22	240	485	345	32,0	
LPC4 65-160/0.92	G2½	65PN10	4	18	122	145	185	400	220	180	118	122	140	22	240	485	345	33,0	
LPC4 65-200/1.1	G2½	65PN10	4	18	122	145	185	440	240	200	149	136	140	22	285	525	385	38,0	
LPC4 65-200/1.5	G2½	65PN10	4	18	122	145	185	440	240	200	149	136	140	22	285	525	385	40,0	
LPC4 65-250/2.2	G2½	65PN10	4	18	122	145	185	475	250	225	170	165	140	22	335	565	425	66,0	
LPC4 65-250/3	G2½	65PN10	4	18	122	145	185	475	250	225	170	165	140	22	335	565	425	66,0	
LPC4 80-160/0.75	G3	80PN10	8	18	138	160	200	440	240	200	118	131	160	24	249	505	345	36,0	
LPC4 80-160/0.92	G3	80PN10	8	18	138	160	200	440	240	200	118	131	160	24	249	505	345	37,0	
LPC4 80-160/1.1	G3	80PN10	8	18	138	160	200	440	240	200	149	131	160	24	280	545	385	38,0	
LPC4 80-160/1.5	G3	80PN10	8	18	138	160	200	440	240	200	149	131	160	24	280	545	385	40,0	
LPC4 80-200/2.2	G3	80PN10	8	18	138	160	200	500	275	225	159	146	160	24	305	585	425	51,0	
LPC4 80-200/3.0	G3	80PN10	8	18	138	160	200	500	275	225	159	146	160	24	305	585	425	57,0	
LPC4 80-250/4	G3	80PN10	8	18	138	160	200	530	280	250	185	168	160	24	353	700	540	84,0	
LPC4 80-250/5.5	G3	80PN10	8	18	138	160	200	530	280	250	185	168	160	24	353	700	540	94,0	
LPC4 100-160/1.5	G4	100PN10	8	18	158	180	220	525	300	225	149	136	190	26	285	575	385	45,0	
LPC4 100-160/2.2	G4	100PN10	8	18	158	180	220	525	300	225	159	136	190	26	295	615	425	50,0	
LPC4 100-200/3.0	G4	100PN10	8	18	158	180	220	550	300	250	159	156	190	26	315	615	425	66,0	
LPC4 100-200/4.0	G4	100PN10	8	18	158	180	220	550	300	250	159	156	190	26	315	625	435	73,0	
LPC4 100-250/5.5	G4	100PN10	8	18	158	180	220	600	320	280	184	176	190	26	360	730	540	96,0	
LPC4 100-250/7.5	G4	100PN10	8	18	158	180	220	600	320	280	184	176	190	26	360	730	540	106,0	
LPC4 125-250/5.5 R	G5	125PN16	8	18	188	210	250	620	340	280	220	195	195	28	415	745	550	132,0	
LPC4 125-250/5.5	G5	125PN16	8	18	188	210	250	620	340	280	220	195	195	28	415	745	550	132,0	
LPC4 125-250/7.5	G5	125PN16	8	18	188	210	250	620	340	280	220	195	195	28	415	745	550	135,0	
LPC4 125-250/9.2	G5	125PN16	8	18	188	210	250	620	340	280	220	195	195	28	415	745	550	138,0	
LPC4 150-250/7.5	G6	150PN16	8	22	212	240	285	700	370	330	250	210	220	28	460	775	555	154,0	
LPC4 150-250/9.2	G6	150PN16	8	22	212	240	285	700	370	330	250	210	220	28	460	775	555	158,0	
LPC4 150-250/11	G6	150PN16	8	22	212	240	285	700	370	330	250	210	220	28	460	775	555	162,0	
LPC4 150-250/15 R	G6	150PN16	8	22	212	240	285	700	370	330	300	210	220	28	510	975	755	201,0	
LPC4 150-250/15	G6	150PN16	8	22	212	240	285	700	370	330	300	210	220	28	510	975	755	201,0	

Data under revision. For more information please contact our sales network.

## IN-LINE CENTRIFUGAL ELECTRIC PUMPS

in cast iron

### LPCD4 40-50-65-80-100 DIMENSIONS

4 Poles

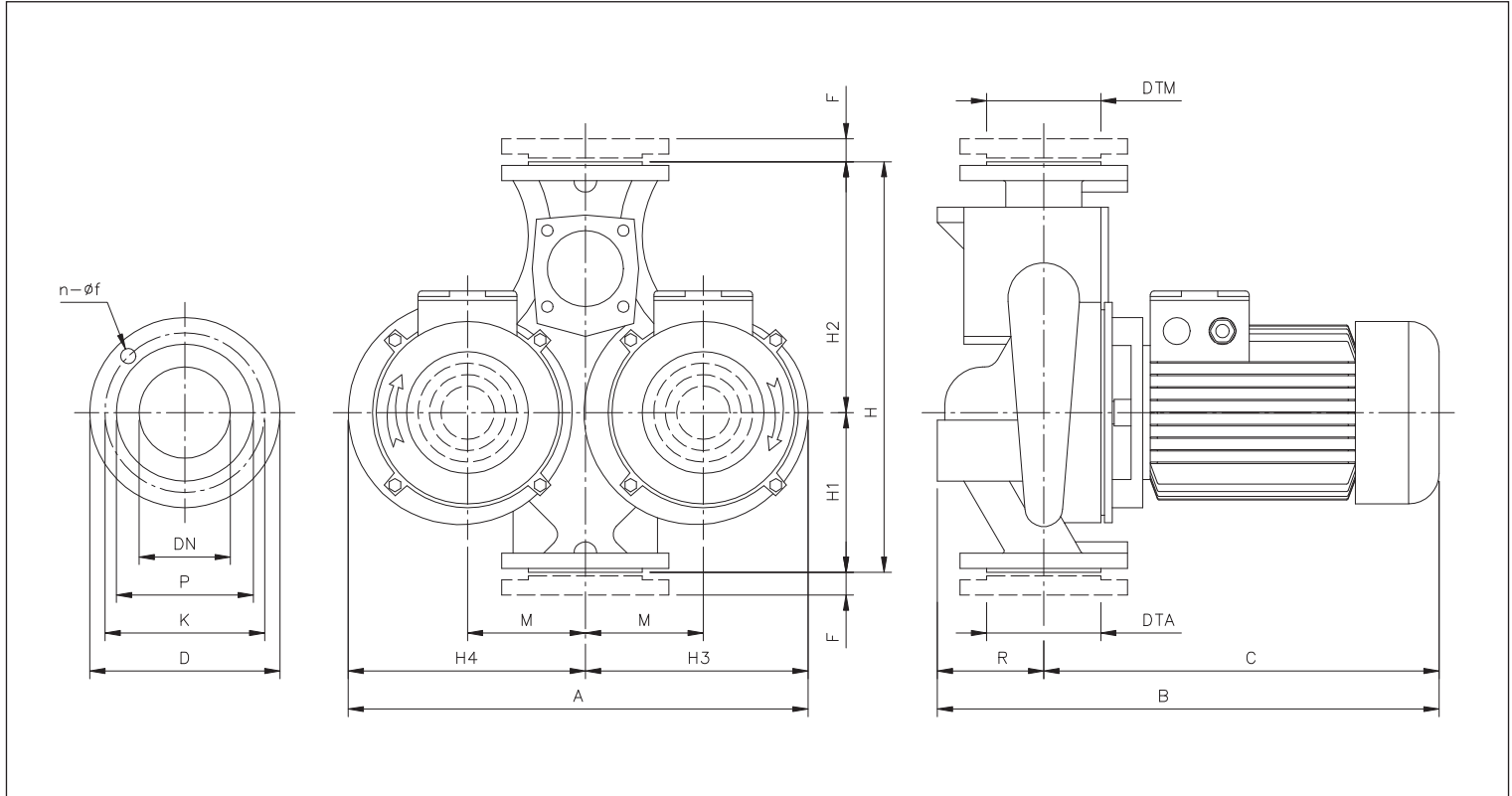

### DIMENSIONS TABLE

Model	Dimensions [mm]																			Weight [kg]
	DTA/M	DNA/M	n	f	P	K	D	H	H1	H2	H3	H4	M	R	F	A	B	C		
LPCD4 40-100/0.25	G1½	40PN10	4	18	88	110	150	340	130	210	197	200	100	100	20	397	425	325	41	
LPCD4 40-125/0.25R	G1½	40PN10	4	18	88	110	150	340	130	210	197	200	100	100	20	397	425	325	41	
LPCD4 40-125/0.25	G1½	40PN10	4	18	88	110	150	340	130	210	197	200	100	100	20	397	425	325	41	
LPCD4 50-125/0.25	G2	50PN10	4	18	102	125	165	365	145	220	210	217	105	110	22	427	435	325	44	
LPCD4 50-125/0.37	G2	50PN10	4	18	102	125	165	365	145	220	210	217	105	110	22	427	435	325	46	
LPCD4 50-160/0.55	G2	50PN10	4	18	102	125	165	410	170	240	235	245	120	110	22	480	435	325	52	
LPCD4 65-160/0.55	G2½	65PN10	4	18	122	145	185	450	180	270	268	275	140	130	22	543	475	345	65	
LPCD4 65-160/0.75	G2½	65PN10	4	18	122	145	185	450	180	270	268	275	140	130	22	543	475	345	65	
LPCD4 65-160/0.92	G2½	65PN10	4	18	122	145	185	450	180	270	268	275	140	130	22	543	475	345	67	
LPCD4 80-160/0.75	G3	80PN10	8	18	138	160	200	510	205	305	270	280	135	150	24	550	485	335	72	
LPCD4 80-160/0.92	G3	80PN10	8	18	138	160	200	510	205	305	270	280	135	150	24	550	485	335	74	
LPCD4 80-160/1.1	G3	80PN10	8	18	138	160	200	510	205	305	270	280	135	150	24	550	535	385	79	
LPCD4 80-160/1.5	G3	80PN10	8	18	138	160	200	510	205	305	270	280	135	150	24	550	535	385	83	
LPCD4 100-200/1.5	G4	100PN10	8	18	158	180	220	630	240	390	345	325	165	180	26	670	535	355	110	
LPCD4 100-200/2.2	G4	100PN10	8	18	158	180	220	630	240	390	345	325	165	180	26	670	605	425	130	
LPCD4 100-200/3.0	G4	100PN10	8	18	158	180	220	630	240	390	345	325	165	180	26	670	605	425	138	
LPCD4 100-200/4.0	G4	100PN10	8	18	158	180	220	630	240	390	345	325	165	180	26	670	615	435	150	

Data under revision. For more information please contact our sales network.

# LPC - LPCD

## IN-LINE CENTRIFUGAL ELECTRIC PUMPS

in cast iron

### LPC - LPC4 SECTIONAL VIEW

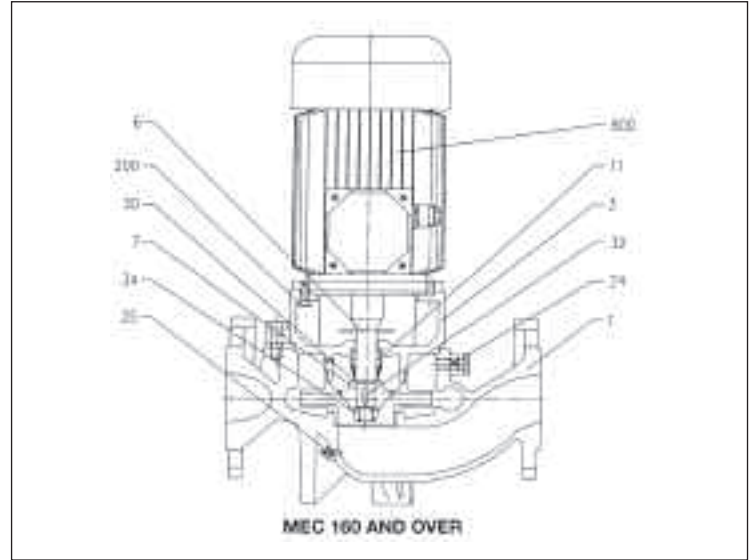
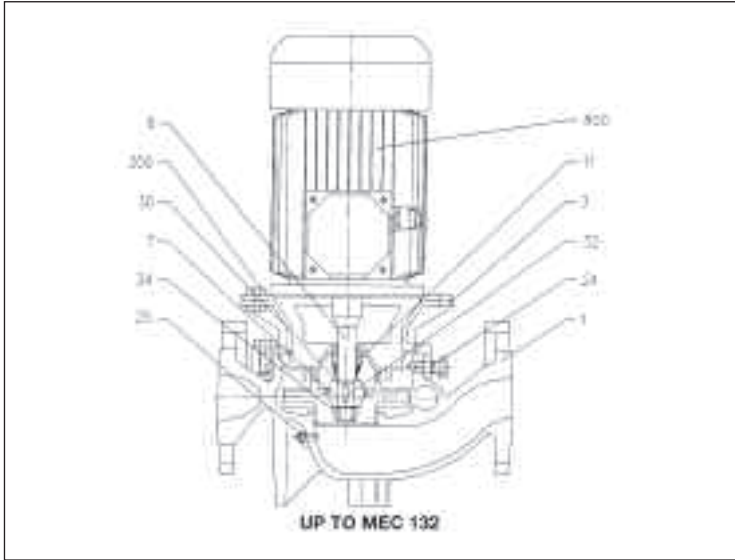

### MATERIALS TABLE

Ref.	Name	Material	Ref.	Name	Material
1	Pump body	Cast iron G 20	25	Drain plug	Stainless steel
3	Motor support	Cast iron	30	Spacer	Stainless steel
6	Shaft	AISI 420	32	Key	Stainless steel
7	Impeller	Cast iron	34	Impeller nut	Stainless steel
11	Mechanical seal	Carbon/SiC/EPDM	200	Screw (pump body)	Stainless steel
24	Filler cap	Stainless steel			

### LPCD - LPCD4 SECTIONAL VIEW

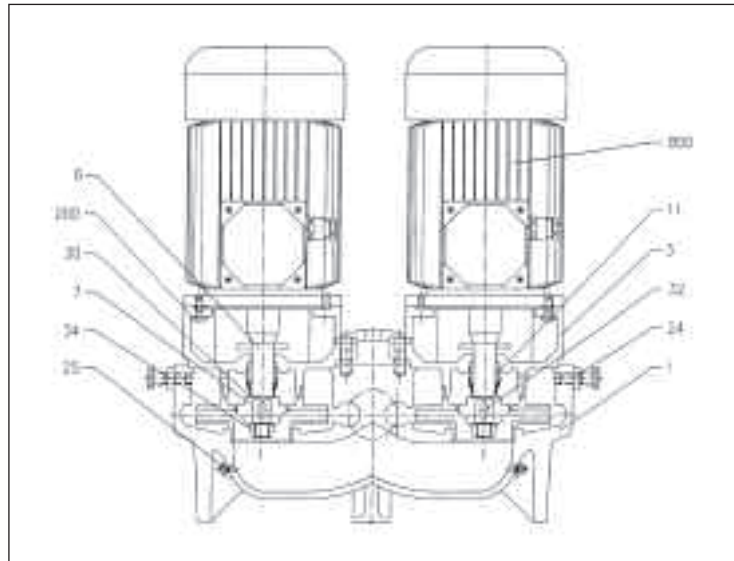

### MATERIALS TABLE

Ref.	Name	Material	Ref.	Name	Material
1	Pump body	Cast iron G 20	25	Drain plug	Stainless steel
3	Motor support	Cast iron	30	Spacer	Stainless steel
6	Shaft	AISI 420	32	Key	Stainless steel
7	Impeller	Cast iron	34	Impeller nut	Stainless steel
11	Mechanical seal	Carbon/SiC/EPDM	200	Screw (pump body)	Stainless steel
24	Filler cap	Stainless steel			

# LPC - LPCD

## IN-LINE CENTRIFUGAL ELECTRIC PUMPS

in cast iron

### MECHANICAL SEAL

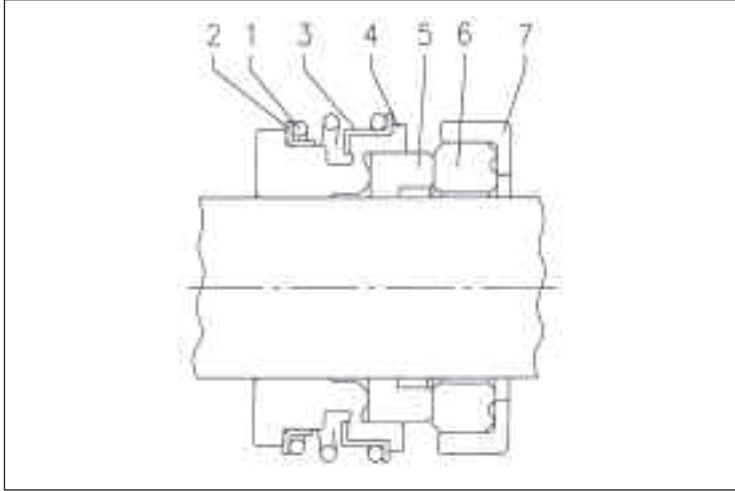

### MATERIALS TABLE

Ref.	Name	Material	
		Standard Max. temperature: 110°C	Optional Max. temperature: 90°C
1	Spring	AISI 316	AISI 316
2	O-Ring	EPDM	NBR
3	Structure/frame	AISI 316	AISI 316
4	O-Ring	EPDM	EPDM
5	Rotating part	Carbon	SiC
6	Fixed part	SiC	SiC
7	Cover in rubber	EPDM	EPDM

### LPC ELECTRIC DATA TABLE

2 Poles

Model	P <sub>2</sub>		Absorbed Current [A]		
	[HP]	[kW]	230V		
			400V	690V	
LPC 40-100/0.55	0,75	0,55	2,8	1,6	-
LPC 40-100/0.75	1	0,75	3,3	1,9	-
LPC 40-125/0.75	1	0,75	3,3	1,9	-
LPC 40-125/1.1	1,5	1,1	1	1,35	-
LPC 40-125/1.5	2	1,5	6,2	3,6	-
LPC 40-160/2.2	3	2,2	7,7	4,4	-
LPC 40-160/3.0	4	3	11	6,4	-
LPC 40-160/4.0	5,5	4	16,2	8,8	-
LPC 40-200/4.0	5,5	4	16,2	8,8	-
LPC 40-200/5.5	7,5	5,5	-	11,3	6,5
LPC 40-200/6.3	8,5	6,3	-	12,8	7,4
LPC 50-125/1.5	2	1,5	6,2	3,6	-
LPC 50-125/2.2	3	2,2	7,7	4,4	-
LPC 50-125/3.0	4	3	11	6,4	-
LPC 50-160/3.0	4	3	11	6,4	-
LPC 50-160/4.0	5,5	4	16,2	8,8	-
LPC 50-200/5.5	7,5	5,5	-	11,3	6,5
LPC 50-200/6.3	8,5	6,3	-	12,8	7,4
LPC 50-200/7.5	10	7,5	-	17,3	10,0
LPC 65-125/2.2	3	2,2	7,7	4,4	-
LPC 65-125/3.0	4	3	11	6,4	-
LPC 65-125/4.0	5,5	4	16,2	8,8	-
LPC 65-160/5.5	7,5	5,5	-	11,3	6,5
LPC 65-160/7.5	10	7,5	-	17,3	10,0
LPC 65-200/10	13,6	10	-	22,5	13,0
LPC 65-200/12.5	17	12,5	-	27	15,5
LPC 80-160/10	13,6	10	-	22,5	13,0
LPC 80-160/12.5	17	12,5	-	27	15,5
LPC 80-160/15	20	15	-	32	18,5
LPC 80-200/15	20	15	-	32	18,5
LPC 80-200/18.5	25	18,5	-	38	22,0
LPC 80-200/22	30	22	-	44,5	25,7
LPC 100-160/10	13,6	10	-	22,5	13,0
LPC 100-160/12.5	17	12,5	-	27	15,5
LPC 100-160/15	20	15	-	32	18,5
LPC 100-200/18.5	25	18,5	-	38	22,0
LPC 100-200/22	30	22	-	44,5	25,7
LPC 100-200/30	40	30	-	68	29,2
LPC 100-200/37	55	37	-	71	41,0
LPC 100-250/37	55	37	-	71	41,0

Data under revision. For more information please contact our sales network.

# LPC - LPCD

## IN-LINE CENTRIFUGAL ELECTRIC PUMPS

in cast iron

LPCD ELECTRIC DATA TABLE

2 Poles

Model	P <sub>2</sub>		Absorbed Current [A]		
	[HP]	[kW]	230V	400V	690V
LPCD 40-125/0.55	0,75	0,55	2,8	1,6	-
LPCD 40-125/0.75	1	0,75	3,3	1,9	-
LPCD 40-125/1.1	1,5	1,1	1	1,35	-
LPCD 40-125/1.5	2	1,5	6,2	3,6	-
LPCD 50-125/1.5	2	1,5	6,2	3,6	-
LPCD 50-125/2.2	3	2,2	7,7	4,4	-
LPCD 50-125/3.0	4	3	11	6,4	-
LPCD 50-160/3.0	4	3	11	6,4	-
LPCD 50-160/4.0	5,5	4	16,2	8,8	-
LPCD 65-160/3.0	4	3	11	6,4	-
LPCD 65-160/4.0	5,5	4	16,2	8,8	-
LPCD 65-160/5.5	7,5	5,5	-	11,3	6,5
LPCD 65-160/7.5	10	7,5	-	17,3	10,0
LPCD 80-160/7.5	10	7,5	-	17,3	10,0
LPCD 80-160/10	13,6	10	-	22,5	13,0
LPCD 80-160/12.5	17	12,5	-	27	15,5
LPCD 80-160/15	20	15	-	32	18,5
LPCD 100-200/12.5	17	12,5	-	27	15,5
LPCD 100-200/15	20	15	-	32	18,5

LPC4 ELECTRIC DATA TABLE

4 Poles

Model	P <sub>2</sub>		Absorbed Current [A]		
	[HP]	[kW]	230V	400V	690V
LPC4 40-100/0.25	0,33	0,25	1,6	0,9	-
LPC4 40-125/0.25 R	0,33	0,25	1,6	0,9	-
LPC4 40-125/0.25	0,33	0,25	1,6	0,9	-
LPC4 40-160/0.37	0,55	0,37	2,3	1,3	-
LPC4 40-200/0.75	1	0,75	3,9	2,25	-
LPC4 40-200/0.92	1,25	0,92	4,7	2,7	-
LPC4 50-125/0.25	0,33	0,25	1,6	0,9	-
LPC4 50-125/0.37	0,55	0,37	2,3	1,3	-
LPC4 50-160/0.55	0,75	0,55	2,8	1,6	-
LPC4 50-200/1.1 R	1,5	1,1	4,85	2,8	-
LPC4 50-200/1.1	1,5	1,1	4,85	2,8	-
LPC4 65-125/0.37	0,55	0,37	2,3	1,3	-
LPC4 65-125/0.55	0,75	0,55	2,8	1,6	-
LPC4 65-160/0.75	1	0,75	3,9	2,25	-
LPC4 65-160/0.92	1,25	0,92	4,7	2,7	-
LPC4 65-200/1.1	1,5	1,1	4,85	2,8	-
LPC4 65-200/1.5	2	1,5	6,6	3,8	-
LPC4 80-160/0.75	1	0,75	3,9	2,25	-
LPC4 80-160/0.92	1,25	0,92	4,7	2,7	-
LPC4 80-160/1.1	1,5	1,1	4,85	2,8	-
LPC4 80-160/1.5	2	1,5	6,6	3,8	-
LPC4 80-200/2.2	3	2,2	10	5,8	-
LPC4 80-200/3	4	3	13,5	7,8	-
LPC4 100-160/1.5	2	1,5	6,6	3,8	-
LPC4 100-160/2.2	3	2,2	10	5,8	-
LPC4 100-200/3	4	3	13,5	7,8	-
LPC4 100-200/4	5,5	4	16,1	9,3	-
LPC4 100-250/5.5	7,5	5,5	-	12	6,9
LPC4 100-250/7.5	10	7,5	-	15,6	9

Data under revision. For more information please contact our sales network.

## IN-LINE CENTRIFUGAL ELECTRIC PUMPS

in cast iron

LPCD4 ELECTRIC DATA TABLE

4 Poles

Model	P <sub>2</sub>		Absorbed Current [A]	
	[HP]	[kW]	230V	400V
LPCD4 40-100/0.25	0,33	0,55	1,6	0,9
LPCD4 40-125/0.25 R	0,33	0,75	1,6	0,9
LPCD4 40-125/0.25	0,33	1,1	1,6	0,9
LPCD4 50-125/0.25	0,33	1,5	1,6	0,9
LPCD4 50-125/0.37	0,55	1,5	2,3	1,3
LPCD4 50-160/0.55	0,75	2,2	2,8	1,6
LPCD4 65-160/0.55	0,75	3	2,8	1,6
LPCD4 65-160/0.75	1	3	3,9	2,25
LPCD4 65-160/0.92	1,25	4	4,7	2,7
LPCD4 80-160/0.75	1	3	3,9	2,25
LPCD4 80-160/0.92	1,25	4	4,7	2,7
LPCD4 80-160/1.1	1,5	5,5	4,85	2,8
LPCD4 80-160/1.5	2	7,5	6,6	3,8
LPCD4 100-160/1.5	2	7,5	6,6	3,8
LPCD4 100-200/2.2	3	10	10	5,8
LPCD4 100-200/3	4	12,5	13,5	7,8
LPCD4 100-200/4	5,5	15	16,1	9,3
LPCD 100-200/12.5	17	12,5	-	27
LPCD 100-200/15	20	15	-	32

### Heating & Conditioning

