

**EBARA**



	Page
<b>- SPECIFICATIONS</b>	<b>200</b>
SPECIFICATION	200
SELECTION CHART PFC	201
SELECTION CHART	202
TYPE KEY AND CURVE SPECIFICATIONS	203
PERFORMANCE CURVE 3TP 2	204
PERFORMANCE CURVE 3TP 3	205
PERFORMANCE CURVE 3TP 5	206
<b>- CONSTRUCTIONS</b>	<b>300</b>
SECTIONAL VIEW DRAWING	300
SECTIONAL VIEW TABLE	301
ITEM QUANTITY FOR MODEL	302
<b>- DIMENSIONS AND WEIGHT</b>	<b>400</b>
PUMP	400
DIMENSIONS	401
PACKING	402
<b>- TECHNICAL DATA</b>	<b>500</b>
OIL FILLED MOTOR	500
CABLE TYPE AND MAXIMUM LENGTH	501

PUMP		
Liquid Handled	Type of liquid	Clean water
	Temperature [°C]	Maximum 35 (depends on maximum temperature motor)
	Sand content	Maximum : 50 parts per million
	Chlorine ion density	Maximum : 500 parts per million
Construction	Impeller	Closed centrifugal
	Bearing	Sleeve type - Alumina (Ceramic) / HNBR rubber
Pipe connection	Suction	N/A
	Discharge	G1 (models 3TP 2 - 3TP 3) UNI ISO 228 G 1 1/4 (models 3TP 5)
Material	Impeller	Noryl (PPO GF30)
	Intermediate casing	Noryl (PPO GF30)
	Diffuser	Noryl (PPO GF30)
	Shaft	EN 1.4301 (AISI 304)
	Discharge casing	EN 1.4308 (ASTM CF8)
	Valve	EN 1.4301 (AISI 304)
	Suction casing	EN 1.4308 (ASTM CF8)
Applicable standard of test		ISO 9906 - Annex A

MOTOR		
Type	Submersible oil filled (type 3HS)	
Manufacturer	Sumoto	
Power rating motors [kW]	Three phase 0,6 ÷ 0,9 ÷ 1,5	
Power rating Inverter [kW]	Single phase 1,5 ÷ 2,5	
No. of Poles	2	
Rated speed	Refer to each characteristic performance rotation speed as rated speed	
Insulation class	F	
Protection degree	IP 68	
Maximum temperature [°C]	35	
Maximum immersion [m]	150	
Starts / hours	no limit	
Start type	Direct on line	
Frequency [Hz]	50 / 60 Hz	
Voltage [V]	200-230(+6-10%)	
Over/under voltage- dry running	By inverter	
Over load protection	By inverter	
Sealing liquid	Oil type: White oil Fu15 (Pakelo)	
Motor bracket	Cast iron cataforetic base coating + SS cover AISI 304	
Casing material	EN 1.4301 (AISI 304)	
Power cable	material	EPDM/Cross Seald Polyethylene
	size [mm <sup>2</sup> ]	3x1.5
	length [m]	L=1.75
Flange mount	3 "	

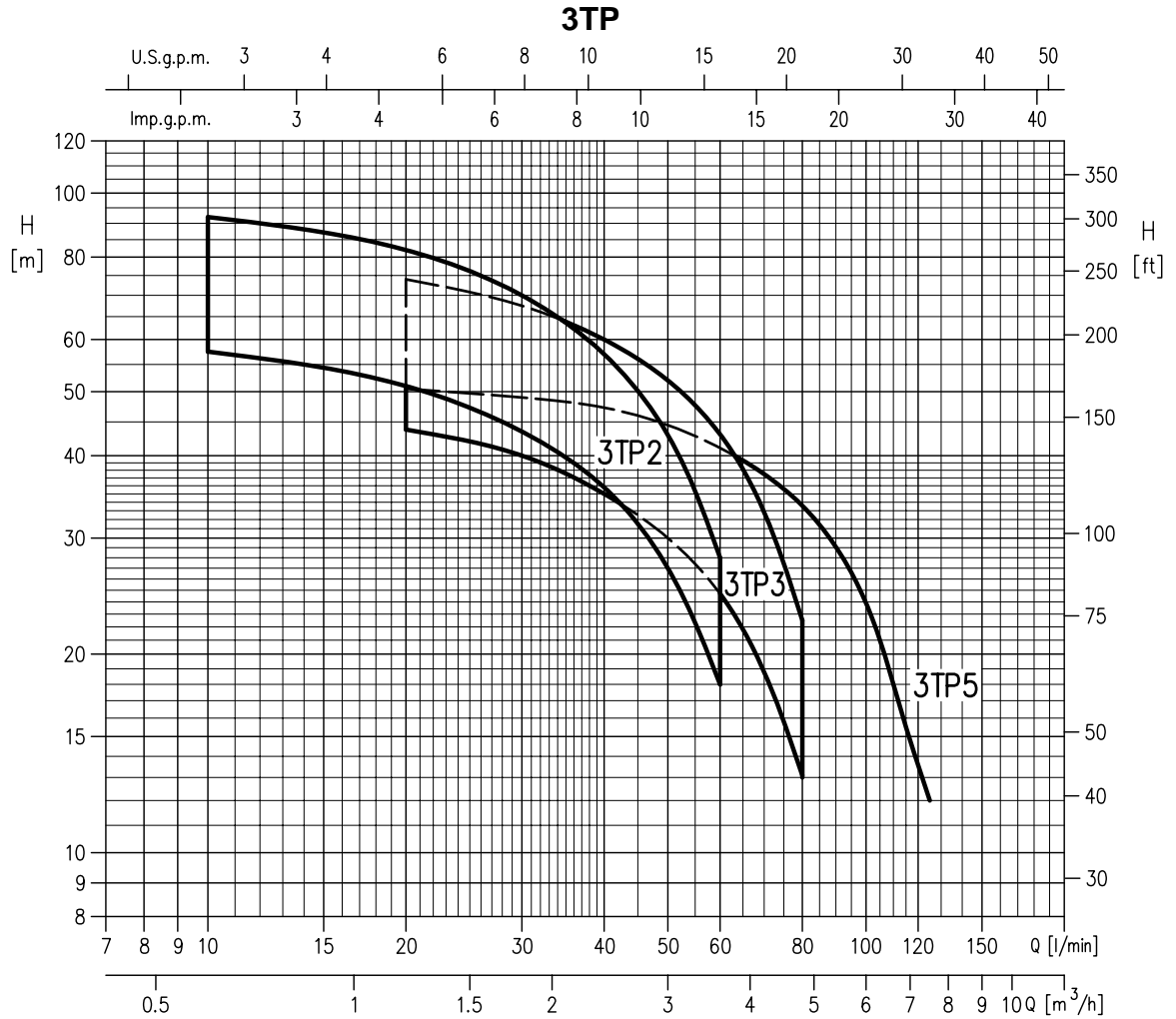

Pump type	Motor		Q=Capacity													
			l/min	0	10	20	30	40	50	60	80	100	115	125		
			m <sup>3</sup> /h	0,0	0,6	1,2	1,8	2,4	3,0	3,6	4,8	6,0	6,9	7,5		
		H=Total Head(m)														
kW	HP															
3TP2	4	0,60	0,8	61	58	51	44	36	27	18	-	-	-	-	-	-
3TP2	6	0,90	1,2	97	92	82	70	57	43	28	-	-	-	-	-	-
3TP3	3	0,60	0,8	49	-	44	40	35	30	25	13	-	-	-	-	-
3TP3	5	0,90	1,2	84	-	74	68	60	52	43	23	-	-	-	-	-
3TP5	4	0,90	1,2	53	-	51	49	47	45	41	34	24	16	12	-	-

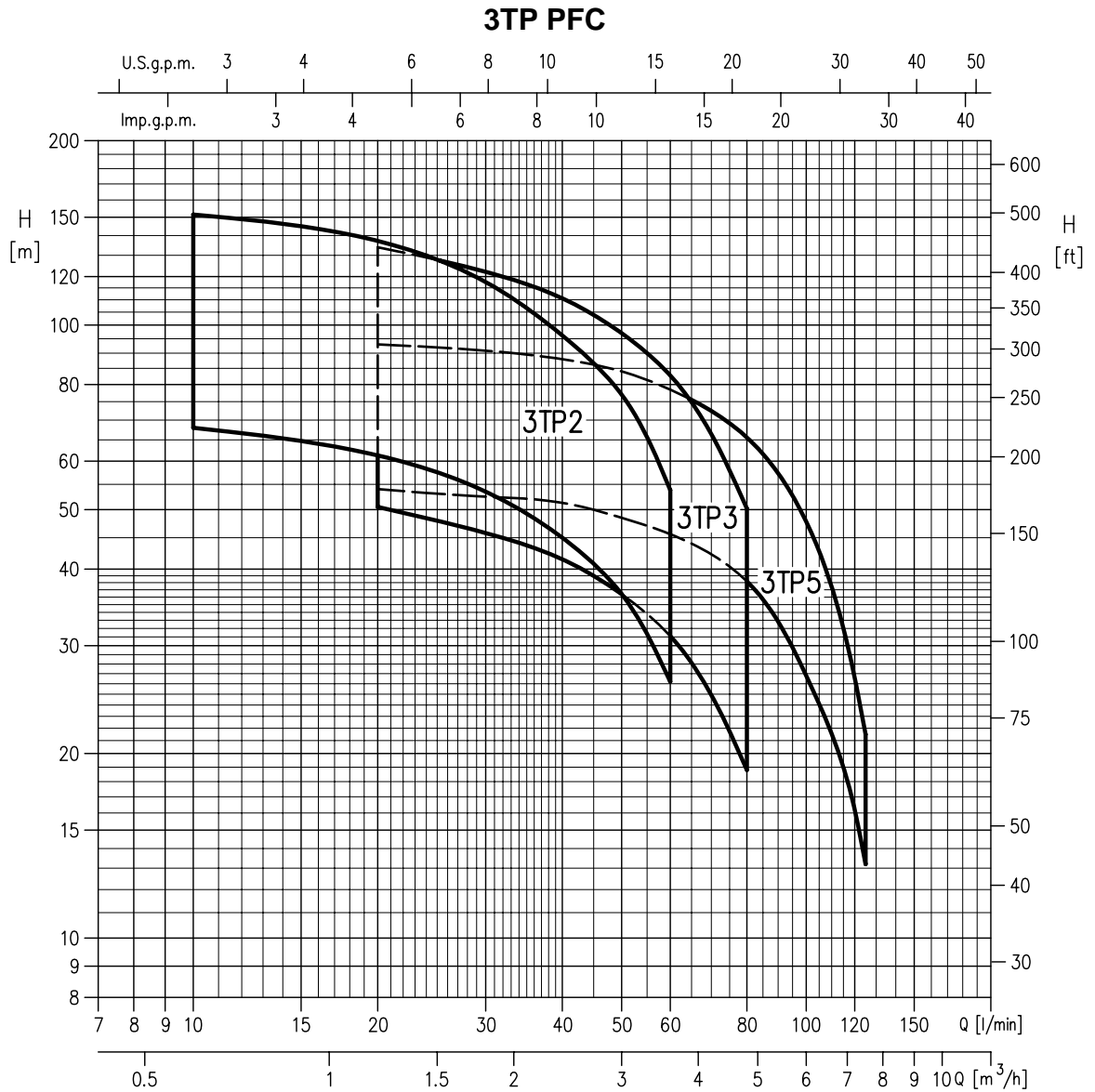

Pump type	Motor		Q=Capacity											
			l/min m³/h	0	10	20	30	40	50	60	80	100	115	125
	kW	HP		0,0	0,6	1,2	1,8	2,4	3,0	3,6	4,8	6,0	6,9	7,5
	H=Total Head(m)													
3TP2 4 PFC	0,60	0,8	71	68	61	54	45	36	26	-	-	-	-	-
3TP2 6 PFC	0,90	1,2	106	102	92	80	66	52	36	-	-	-	-	-
3TP2 9 PFC	1,50	2,0	158	152	137	118	96	77	54	-	-	-	-	-
3TP3 3 PFC	0,60	0,8	55	-	51	46	42	36	31	19	-	-	-	-
3TP3 5 PFC	0,90	1,2	91	-	84	76	69	61	52	31	-	-	-	-
3TP3 8 PFC	1,50	2,0	146	-	134	122	111	97	83	50	-	-	-	-
3TP5 4 PFC	0,90	1,2	56	-	54	53	51	49	46	38	27	19	13	
3TP5 7 PFC	1,50	2,0	96	-	93	91	88	84	79	66	48	32	22	

### TYPE KEY

EXAMPLE ( pump with motor ) :

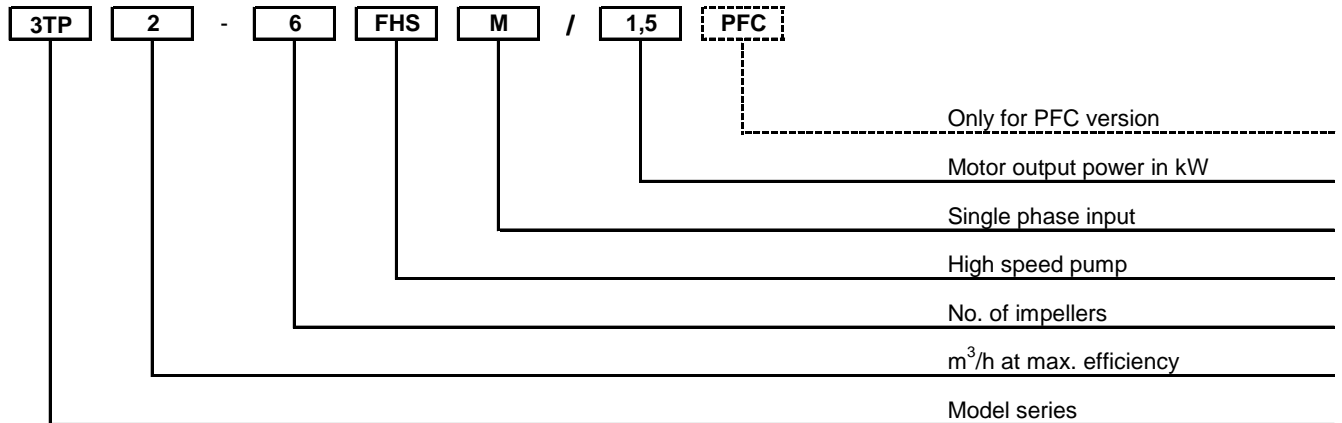

### PERFORMANCE CURVE SPECIFICATIONS

The specifications below qualify the curves shown on the following pages.

- ◆ Tolerances according to ISO 9906 Annex A
- ◆ The curves refer to effective speed of asynchronous motors at 140 Hz
- ◆ Measurements were carried out with clean water at 20°C of temperature and with a kinematic viscosity of  $\nu = 1 \text{ mm}^2/\text{s}$  (1 cSt)
- ◆ The continuous curves indicate the recommended working range. The dotted curve is only a guide.
- ◆ In order to avoid the risk of over-heating, the pumps should not be used at a flow rate below 10% of best efficiency point.
- ◆ Symbols explanation:

Q = volume flow rate

H = total head

$P_2$  = pump power input (shaft power)

$\eta$  = pump efficiency

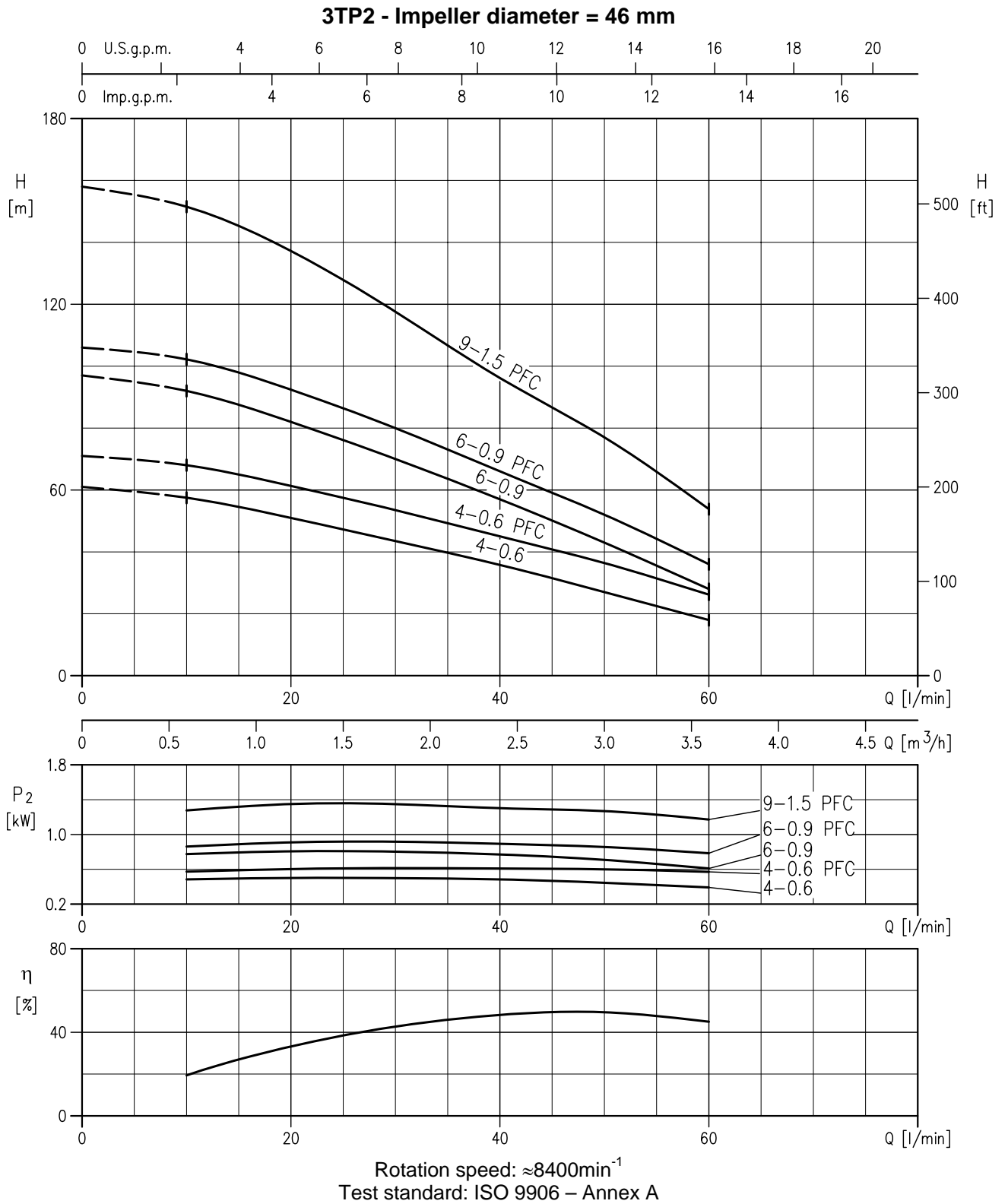

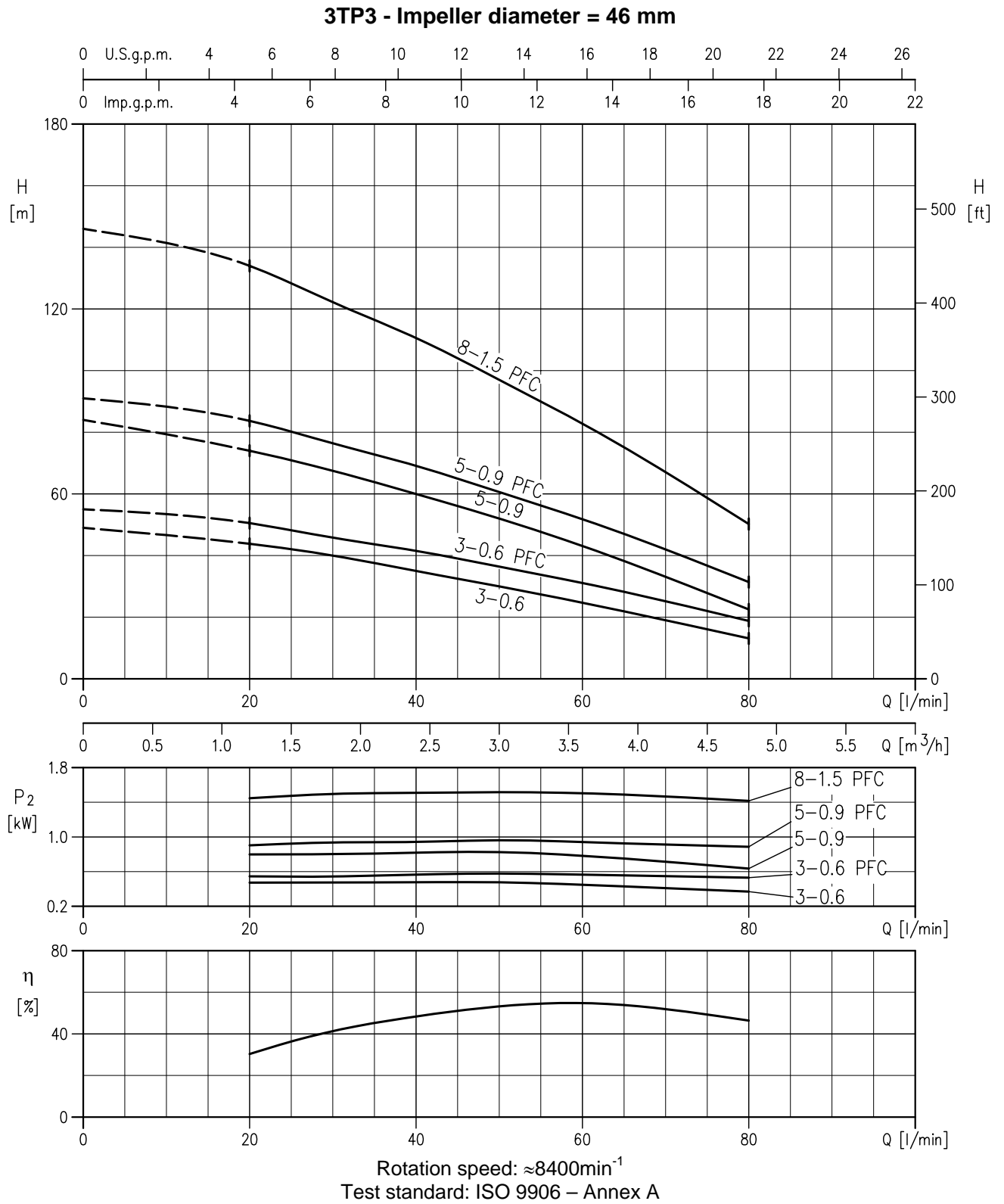



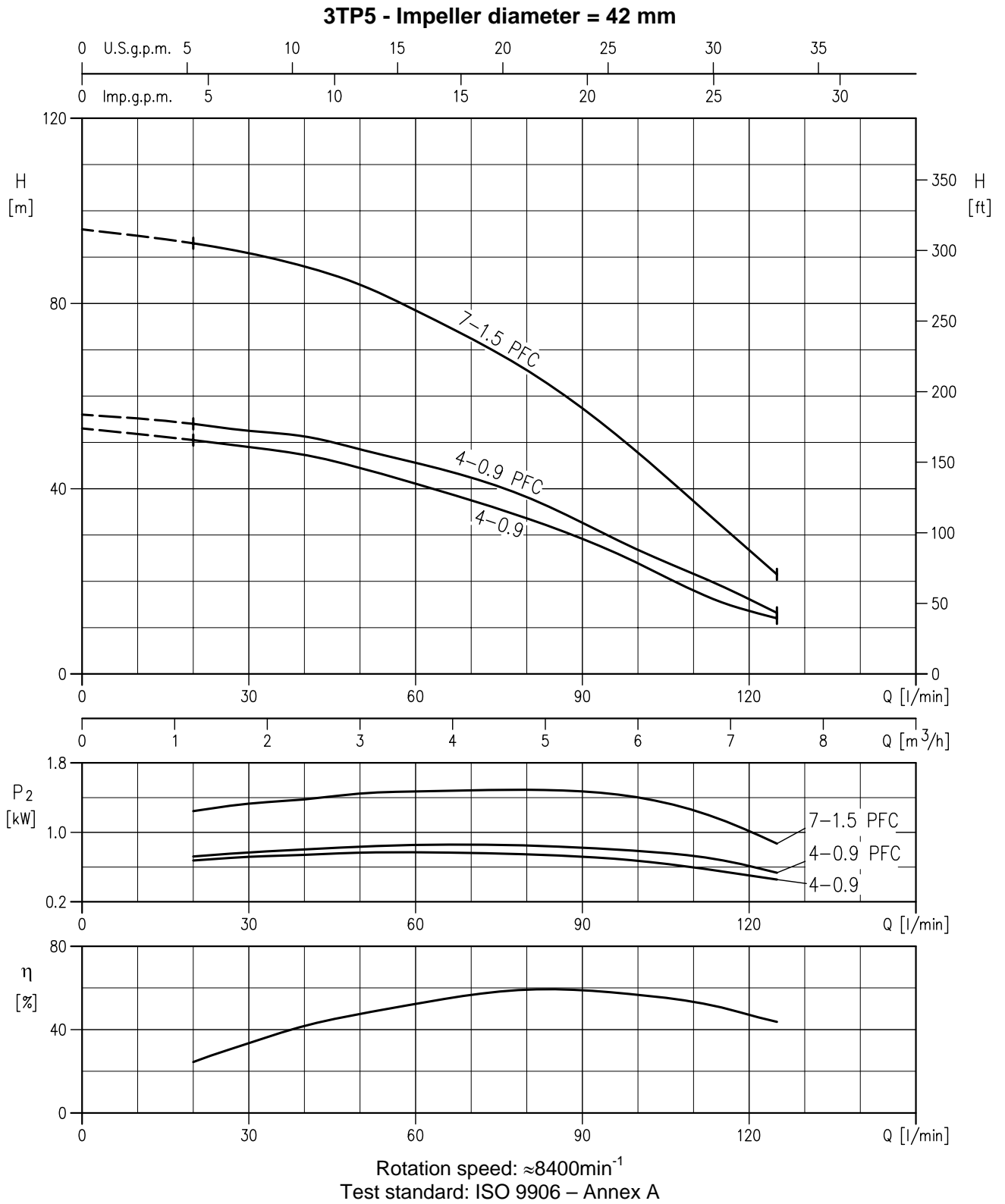

SECTIONAL VIEW DRAWING

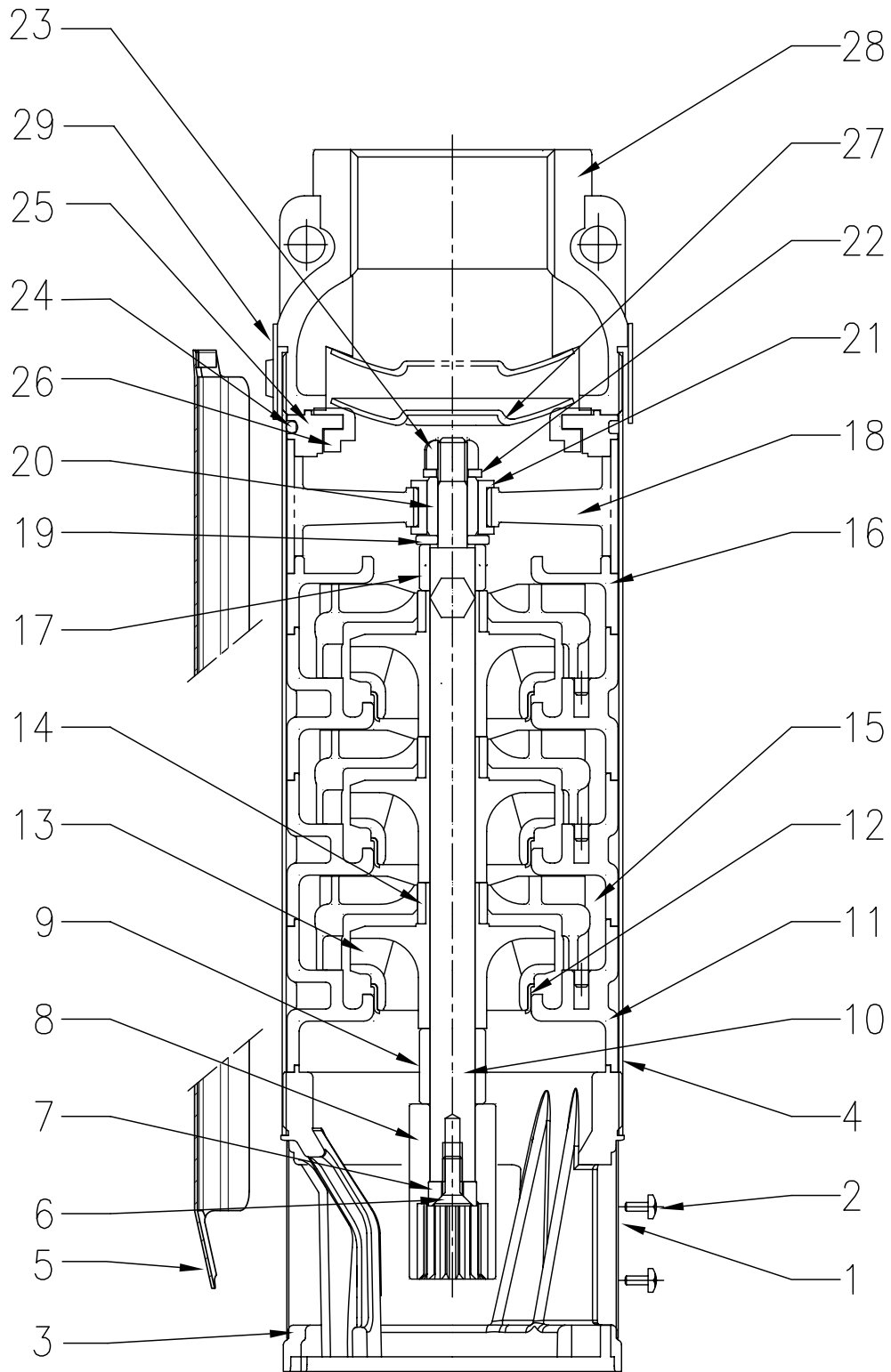

## SECTIONAL VIEW TABLE

Pos.	Part name	Q.ty	Material
1	Strainer	1	AISI304
2	Screw	2	AISI304
3	Pump bracket	1	AISI304
4	Outer casing	1	AISI304
5	Cable cover	1	AISI304
6	Screw	1	AISI304
7	Washer	1	AISI304
8	Coupling splined	1	AISI304
9	Spacer	1	Noryl GF30
10	Shaft	1	AISI304
11	Stage housing	[1]	Noryl GF30
12	Wear ring	[1]	AISI304
13	Impeller	[1]	Noryl GF30
14	Wear ring	[1]	Alumina
15	Diffuser	[1]	Noryl GF30
16	Stage cover	1	Noryl GF30
17	Spacer	1	Noryl GF30
18	Upper bracket	1	Noryl GF30
19	Bearing washer	1	AISI303
20	Shaft sleeve bearing	1	Alumina
21	Bearing	1	HNBR
22	Washer	1	AISI304
23	Nut	1	AISI304
24	O-ring	1	NBR
25	Valve seat	1	Noryl GF30
26	Valve seal ring	1	NBR
27	Valve disc	1	AISI304
28	Discharge bracket	1	AISI304
29	Cable cover holder(kit)	1	AISI304

[1] See page 302

Type pumps	QUANTITY FOR MODEL				
	N°11 St. housing	N°12 Wear ring	N°13 Impeller	N°14 Wear ring	N°15 Diffuser
<b>3TP2 4</b>	4	4	4	4	4
<b>3TP2 6</b>	6	6	6	6	6
<b>3TP2 9</b>	9	9	9	9	9
<b>3TP3 3</b>	3	3	3	3	3
<b>3TP3 5</b>	5	5	5	5	5
<b>3TP3 8</b>	8	8	8	8	8
<b>3TP5 4</b>	4	4	4	4	4
<b>3TP5 7</b>	7	7	7	7	7

PUMP

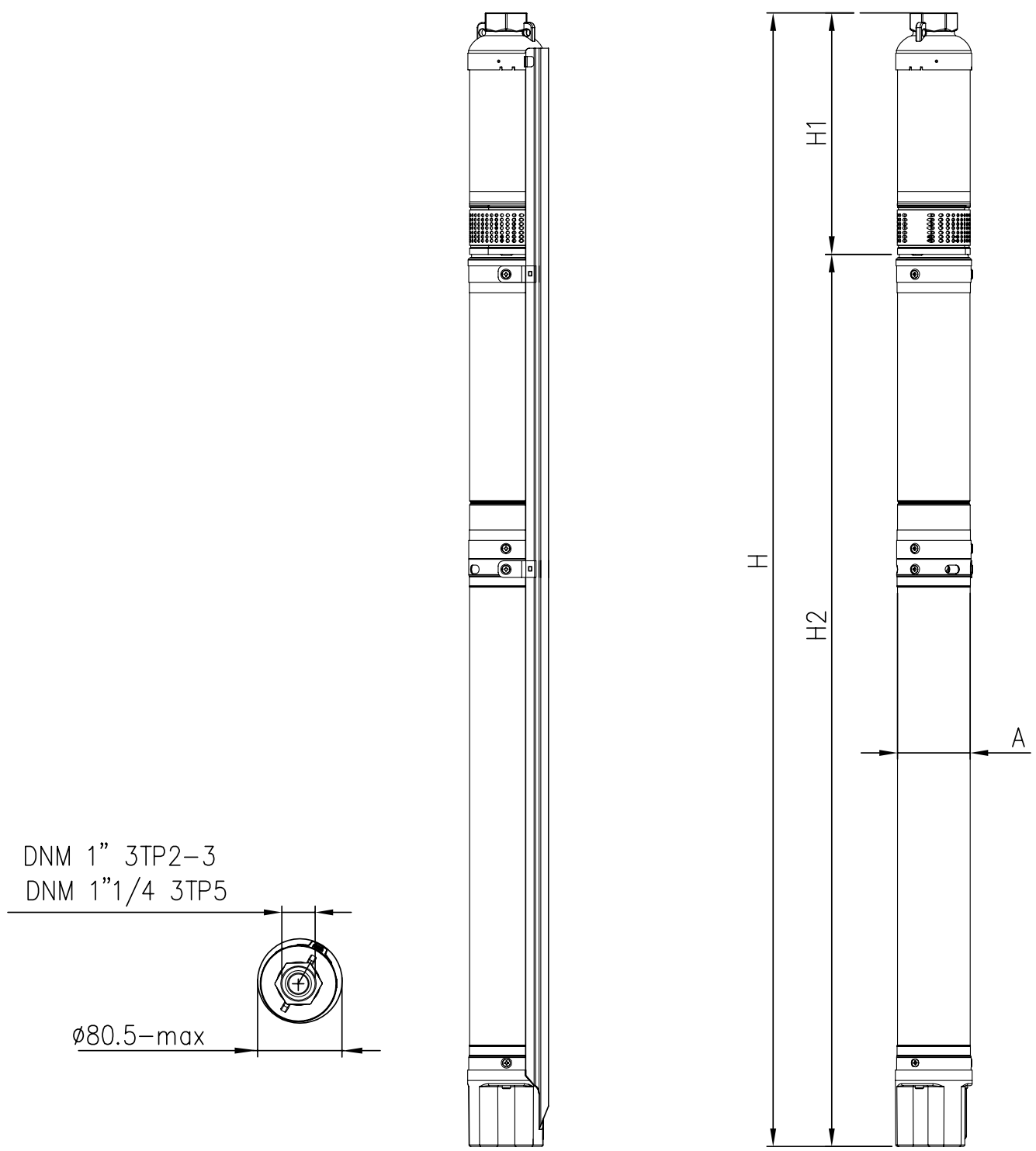

## DIMENSIONS

Pump type	Power		Pump without motor		Pump with motor		
	kW	HP	H1 [mm]	DNM	A* [mm]	H2 [mm]	H [mm]
3TP2-4	0,6	0,8	255	G 1	80	661	916
3TP2-4 PFC	0,6	0,8	255	G 1	80	785	1040
3TP2-6	0,9	1,2	304	G 1	80	691	995
3TP2-6 PFC	0,9	1,2	304	G 1	80	815	1119
3TP2-9 PFC	1,5	2,0	377	G 1	80	845	1222
3TP3-3	0,6	0,8	230	G 1	80	661	891
3TP3-3 PFC	0,6	0,8	230	G 1	80	785	1015
3TP3-5	0,9	1,2	279	G 1	80	691	970
3TP3-5 PFC	0,9	1,2	279	G 1	80	815	1094
3TP3-8 PFC	1,5	2,0	353	G 1	80	845	1198
3TP5-4	0,9	1,2	277	G 1 1/4	80	691	968
3TP5-4 PFC	0,9	1,2	277	G 1 1/4	80	815	1092
3TP5-7 PFC	1,5	2,0	367	G 1 1/4	80	845	1212

\*tolerance 0/+0.5mm

**PACKING**

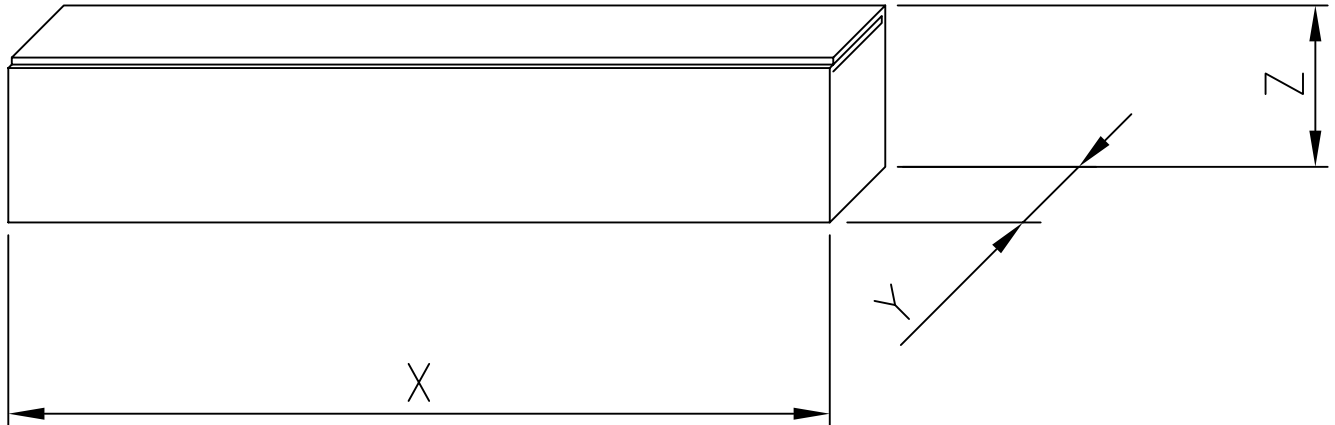

Pump type	Pump Weight [Kgf]	Pump with motor complete VFD integrated			
		X [mm]	Y [mm]	Z [mm]	Weight [Kgf]
3TP2-4	1,4	1182	100	106	9,0
3TP2-4 PFC	1,4	1182	100	106	10,3
3TP2-6	1,6	1182	100	106	9,8
3TP2-6 PFC	1,6	1182	100	106	11,1
3TP2-9 PFC	1,9	1300	100	106	12,1
3TP3-3	1,3	1182	100	106	8,8
3TP3-3 PFC	1,3	1182	100	106	10,1
3TP3-5	1,5	1182	100	106	9,7
3TP3-5 PFC	1,5	1182	100	106	11,0
3TP3-8 PFC	1,8	1300	100	106	12,0
3TP5-4	1,5	1182	100	106	9,7
3TP5-4 PFC	1,5	1182	100	106	11,0
3TP5-7 PFC	1,8	1300	100	106	12,0

Note: special packing available for pumps with long cable connector

## oil filled motor

Output power		Single phase NO PFC				
		Input [kW]	Volt [V]	line [A]	Efficiency [%]	Power factor
[kW]	HP					
0,6	0,8	1,21	230	8,6	49,7	0,6
0,9	1,2	1,57		10,2	57,3	0,7

Output power		Single phase PFC				
		Input [kW]	Volt [V]	line [A]	Efficiency [%]	Power factor
[kW]	HP					
0,6	0,8	1,15	230	5,9	52,2	0,9
0,9	1,2	1,49		7,2	60,4	0,9
1,5	2,0	2,36		11,4	63,6	0,9



**EXAMPLE : MOTOR 1,5 kW 230 V CABLE LENGTH 90 m - 4x4 mm2****Single phase**

POWER		CABLE TYPE AND MAXIMUM LENGTH (*)			
kW	HP	3x1,5mm <sup>2</sup>	3x2,5mm <sup>2</sup>	3x4mm <sup>2</sup>	3x6mm <sup>2</sup>
0,6	0,8	70	120	180	270
0,9	1,2	60	85	125	190
1,5	2,0	55	75	90	140

(\*) Maximum cable length with a voltage drop of 4% at 30°C ambient temperature

